

Monobloc horizontal centrifugal pumps, constructed in compliance with EN 733 standards; widely used in water supplies, pressurisation and fire-fighting systems, cooling, heating, irrigation, industrial and agricultural applications; standard supply with counter-flange.

Construction features

Pump body	cast iron
Motor bracket	cast iron
Impeller	cast iron, bronze or stainless steel
Mechanical seal	ceramic-graphite-NBR
Pump shaft end	stainless steel AISI 304
Liquid temperature	-10 ÷ +90 °C
Operating pressure	max 10 bar

Motor

	3~ 230/400V - 50Hz P ≤ 4kW
2 Poles induction motor	3~ 400/690V - 50Hz P > 4kW
	1~ 230V-50Hz
Insulation class	F
Protection degree	IPX5

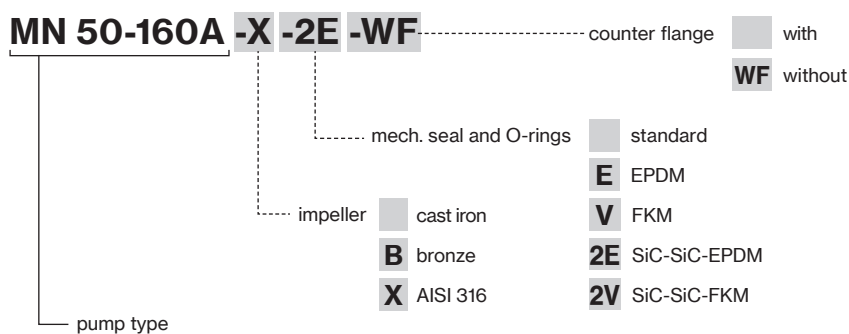

MN-MNG-MA-4MA

Centrifugal Flanged
EN 733

MN: Front suction close-coupled centrifugal pumps with close impeller mounted on IE3 motor shaft extension. Pump casing with axial suction and radial delivery on top, main dimensions and performance according to EN 733.

MNG-MNGX: Front suction centrifugal pumps connected to IE3 standard motor (stub-shaft construction). Pump casing with axial suction and radial delivery on top, main dimensions and performance according to EN 733.

MA-MAX-4MA-4MAX: Single-stage end-suction centrifugal frame-mounted pumps. Dimensions in accordance with EN 733.

TYPE	2 POLES						4 POLES				
	MN	MNG	MNGX	MA	MAX	Flow rate	Head	4MA	4MAX	Flow rate	Head
						m ³ /h	m			m ³ /h	m
32-160C	■	-	-	■	■	6 ÷ 21	22,8 ÷ 14	■	■	1,5 ÷ 12	5,9 ÷ 2,6
32-160B	■	-	-	■	■	6 ÷ 24	27,7 ÷ 17	■	■	1,5 ÷ 12	7,2 ÷ 3,6
32-160A	■	-	-	■	■	6 ÷ 27	36,2 ÷ 22,1	■	■	1,5 ÷ 15	8,8 ÷ 4
32-200C	■	-	-	■	■	6 ÷ 27	40,3 ÷ 28,7	■	■	3 ÷ 18	10,8 ÷ 4,2
32-200B1	■	-	-	-	-	6 ÷ 27	48 ÷ 37,9	-	-	-	-
32-200B	■	-	-	■	■	6 ÷ 30	48 ÷ 35,4	■	■	3 ÷ 18	12,7 ÷ 6,3
32-200A1	■	-	-	-	-	6 ÷ 30	58,3 ÷ 46,6	-	-	-	-
32-200A	■	-	-	■	■	6 ÷ 33	58,3 ÷ 44,3	■	■	3 ÷ 21	15,7 ÷ 6,8
32-250C	■	-	-	■	■	6 ÷ 27	72 ÷ 61,3	■	■	3 ÷ 21	17,2 ÷ 6,5
32-250B	■	-	-	■	■	7,5 ÷ 27	84 ÷ 73,2	■	■	3 ÷ 21	20 ÷ 8,3
32-250A1	■	-	-	-	-	7,5 ÷ 27	93,6 ÷ 85,3	-	-	-	-
32-250A	■	-	-	■	■	7,5 ÷ 27	93,6 ÷ 85,5	■	■	3 ÷ 21	22,2 ÷ 9,1
40-125C	■	-	-	■	■	9 ÷ 36	18,5 ÷ 9,4	■	■	4,5 ÷ 21	4,4 ÷ 2
40-125B	■	-	-	■	■	9 ÷ 39	23,4 ÷ 13,2	■	■	4,5 ÷ 21	5,5 ÷ 3,3
40-125A	■	-	-	■	■	9 ÷ 42	27,6 ÷ 16,8	■	■	4,5 ÷ 24	6,3 ÷ 3,4
40-160B	■	-	-	■	■	9 ÷ 36	29,2 ÷ 20,5	■	■	4,5 ÷ 24	7,5 ÷ 2,5
40-160A	■	-	-	■	■	9 ÷ 42	34,9 ÷ 23,4	■	■	4,5 ÷ 24	8,9 ÷ 4,5
40-160AP	■	-	-	■	■	9 ÷ 48	39,8 ÷ 25,3	■	■	4,5 ÷ 24	11,1 ÷ 6,8
40-200B1	■	-	-	-	-	9 ÷ 39	45,5 ÷ 32,3	-	-	-	-
40-200B	■	-	-	■	■	9 ÷ 42	45,5 ÷ 29,4	■	■	6 ÷ 24	11,4 ÷ 4,7
40-200A1	■	-	-	-	-	9 ÷ 39	56,5 ÷ 44,4	-	-	-	-
40-200A	■	-	-	■	■	9 ÷ 42	56,5 ÷ 41,6	■	■	6 ÷ 24	13,9 ÷ 8,3
40-200AP	■	-	-	■	■	9 ÷ 45	61,4 ÷ 42,2	■	■	6 ÷ 24	14,9 ÷ 9,4
40-250C	■	-	-	■	■	9 ÷ 36	64,4 ÷ 55,4	■	■	9 ÷ 27	15,2 ÷ 6,6
40-250B	■	-	-	■	■	9 ÷ 39	79,9 ÷ 62,1	■	■	9 ÷ 30	18,2 ÷ 8,3
40-250A1	■	-	-	-	-	9 ÷ 42	84,6 ÷ 72,8	-	-	-	-
40-250A	■	-	-	■	■	9 ÷ 45	84,6 ÷ 69	■	■	9 ÷ 33	20,8 ÷ 8,4
40-250BM	■	-	-	■	■	9 ÷ 54	93,2 ÷ 72	-	-	-	-
40-250AM	■	-	-	■	■	9 ÷ 60	103 ÷ 77,5	-	-	-	-
50-125B	■	-	-	■	■	12 ÷ 72	20,6 ÷ 9,2	■	■	9 ÷ 42	5,5 ÷ 2,1
50-125A	■	-	-	■	■	12 ÷ 72	24,3 ÷ 14,2	■	■	9 ÷ 45	6,4 ÷ 2,9
50-160B1	■	-	-	-	-	21 ÷ 66	33,5 ÷ 21,5	-	-	-	-
50-160B	■	-	-	■	■	21 ÷ 72	33,5 ÷ 18,9	■	■	9 ÷ 42	8 ÷ 2,3
50-160A1	■	-	-	-	-	21 ÷ 72	39,8 ÷ 27,6	-	-	-	-
50-160A	■	-	-	■	■	21 ÷ 78	39,8 ÷ 25,4	■	■	9 ÷ 48	9,4 ÷ 3,1
50-200C	■	-	-	■	■	24 ÷ 72	49,7 ÷ 28,9	■	■	9 ÷ 39	12 ÷ 3,2
50-200B	■	-	-	■	■	24 ÷ 72	54,6 ÷ 35	■	■	10,5 ÷ 42	13,1 ÷ 4,2
50-200A1	■	-	-	-	-	24 ÷ 78	61,8 ÷ 39,8	-	-	-	-

TYPE	2 POLES						4 POLES					
	MN	MNG	MNGX	MA	MAX	Flow rate	Head	4MA	4MAX	Flow rate	Head	
						m ³ /h	m			m ³ /h	m	
50-200A	■	-	-	■	■	24 ÷ 78	61,8 ÷ 39,8	■	■	10,5 ÷ 45	14,7 ÷ 4,6	
50-250C1	■	-	-	-	-	27 ÷ 60	68,2 ÷ 56,2	-	-	-	-	
50-250C	■	-	-	■	■	27 ÷ 66	68,2 ÷ 52,1	■	■	12 ÷ 45	17,7 ÷ 7,5	
50-250B	■	-	-	■	■	27 ÷ 72	78,4 ÷ 58,5	■	■	12 ÷ 48	20 ÷ 8,2	
50-250A	■	-	-	■	■	27 ÷ 78	88,3 ÷ 61,8	■	■	12 ÷ 54	22,9 ÷ 8,4	
50-315DN	-	-	-	■	-	42 ÷ 132	90,4 ÷ 73,4	-	-	-	-	
50-315C	-	-	-	-	-	-	-	■	■	18 ÷ 84	24,7 ÷ 16,8	
50-315CN	-	-	-	■	-	42 ÷ 132	105 ÷ 88,7	-	-	-	-	
50-315B	-	-	-	-	-	-	-	■	■	18 - 90	31,4 - 21,6	
50-315BN	-	-	-	■	-	42 ÷ 144	124,3 ÷ 103,5	-	-	-	-	
50-315A	-	-	-	-	-	-	-	■	■	18 - 96	37,2 - 25,1	
50-315AN	-	-	-	■	-	42 ÷ 144	146,9 ÷ 125,8	-	-	-	-	
65-125B1	■	-	-	-	-	30 ÷ 108	20,6 ÷ 15	-	-	-	-	
65-125B	■	-	-	■	■	30 ÷ 120	20,6 ÷ 13,1	■	■	18 ÷ 60	5,1 ÷ 2,8	
65-125A1	■	-	-	-	-	30 ÷ 120	25,2 ÷ 18,8	-	-	-	-	
65-125A	■	-	-	■	■	30 ÷ 132	25,2 ÷ 16,8	■	■	18 ÷ 72	6,3 ÷ 3	
65-160C	■	-	-	■	■	42 ÷ 144	30,6 ÷ 13,9	■	■	24 ÷ 78	7,6 ÷ 2,9	
65-160B	■	-	-	■	■	42 ÷ 144	35,1 ÷ 20,4	■	■	24 ÷ 78	8,6 ÷ 3,6	
65-160A1	■	-	-	-	-	42 ÷ 138	42,5 ÷ 31,7	-	-	-	-	
65-160A	■	-	-	■	■	42 ÷ 144	42,5 ÷ 30,9	■	■	24 ÷ 84	9,9 ÷ 4,6	
65-200C1	■	-	-	-	-	54 ÷ 132	46,1 ÷ 28,9	-	-	-	-	
65-200C	■	-	-	■	■	54 ÷ 138	46,1 ÷ 26,8	■	■	27 ÷ 84	11,6 ÷ 5	
65-200B	■	-	-	■	■	54 ÷ 144	53,9 ÷ 34,6	■	■	27 ÷ 84	13,1 ÷ 7	
65-200A	■	-	-	■	■	54 ÷ 144	61,8 ÷ 44,4	■	■	27 ÷ 84	14,8 ÷ 9,3	
65-250B	■	-	-	■	■	54 ÷ 144	80,6 ÷ 47,3	■	■	27 ÷ 84	21 ÷ 8,7	
65-250A	■	-	-	■	■	54 ÷ 150	91,6 ÷ 57,9	■	■	30 ÷ 90	22,9 ÷ 8,8	
65-315CM	-	-	-	-	-	-	-	■	■	27 ÷ 126	23,5 ÷ 13,9	
65-315CN	-	-	-	■	-	54 ÷ 180	96,5 ÷ 80,8	-	-	-	-	
65-315BM	-	-	-	-	-	-	-	■	■	27 ÷ 132	28,9 ÷ 17,2	
65-315BN	-	-	-	■	-	54 ÷ 195	117,9 ÷ 96,3	-	-	-	-	
65-315AM	-	-	-	-	-	-	-	■	■	27 ÷ 138	34 ÷ 18,2	
65-315AN	-	-	-	■	-	54 ÷ 210	138,8 ÷ 110,4	-	-	-	-	
80-160E	■	-	-	■	■	66 ÷ 168	22,9 ÷ 13,7	■	■	24 ÷ 96	5,7 ÷ 2,2	
80-160D	■	-	-	■	■	66 ÷ 180	27,3 ÷ 16,4	■	■	27 ÷ 102	6,8 ÷ 2,6	
80-160C1	■	-	-	-	-	66 ÷ 195	30,9 ÷ 18,4	-	-	-	-	
80-160C	■	-	-	■	■	66 ÷ 195	30,9 ÷ 18,4	■	■	30 ÷ 108	7,4 ÷ 3,1	
80-160B	■	-	-	■	■	66 ÷ 210	35,9 ÷ 22	■	■	33 ÷ 120	8,9 ÷ 3,5	
80-160A	■	-	-	■	■	66 ÷ 225	40,5 ÷ 23,9	■	■	36 ÷ 132	9,8 ÷ 3,8	
80-200B	■	-	-	■	■	72 ÷ 225	54,5 ÷ 38,5	■	■	42 ÷ 132	13,1 ÷ 7,1	
80-200A	■	-	-	■	■	72 ÷ 240	61,7 ÷ 43,9	■	■	42 ÷ 144	14,7 ÷ 7,5	
80-250B	-	■	■	■	■	96 ÷ 225	80 ÷ 58,8	■	■	42 ÷ 132	19,2 ÷ 11,1	
80-250A	-	■	■	■	■	96 ÷ 240	92,8 ÷ 65,2	■	■	42 ÷ 144	22,9 ÷ 12,6	
80-315B	-	-	-	-	-	-	-	■	■	42 ÷ 150	28,3 ÷ 19,9	
80-315BN	-	-	-	■	-	78 ÷ 255	112,4 ÷ 90,8	-	-	-	-	
80-315A	-	-	-	-	-	-	-	■	■	42 ÷ 168	35 ÷ 23,7	
80-315AN	-	-	-	■	-	78 ÷ 255	141,4 ÷ 118,5	-	-	-	-	
100-160B	■	-	-	-	-	96 ÷ 330	40,7 ÷ 25,7	-	-	-	-	
100-160A	■	-	-	-	-	96 ÷ 330	45,1 ÷ 31,9	-	-	-	-	
100-200D	-	-	-	■	■	108 ÷ 300	43,1 ÷ 26,6	■	■	48 ÷ 168	10,8 ÷ 4,8	
100-200C	-	-	-	■	■	108 ÷ 330	48,4 ÷ 28,1	■	■	48 ÷ 168	12 ÷ 6,3	
100-200B	-	■	■	■	■	108 ÷ 330	56,8 ÷ 39,7	■	■	48 ÷ 180	13,6 ÷ 7,8	
100-200A	-	■	■	■	■	108 ÷ 360	62,2 ÷ 42,5	■	■	48 ÷ 192	15,4 ÷ 9,1	
100-250E	-	-	-	-	-	-	-	■	■	60 ÷ 180	16,9 ÷ 11,4	
100-250D	-	-	-	-	-	-	-	■	■	60 ÷ 192	19,6 ÷ 12,7	

TYPE	2 POLES						4 POLES					
	MN	MNG	MNGX	MA	MAX	Flow rate	Head	4MA	4MAX	Flow rate	Head	
						m ³ /h	m			m ³ /h	m	
100-250C	-	■	■	■	■	120 ÷ 300	73,2 ÷ 61	-	-	-	-	
100-250B	-	■	■	■	■	120 ÷ 330	83,7 ÷ 67,6	-	-	-	-	
100-250A	-	■	■	■	■	120 ÷ 360	93,9 ÷ 73,2	■	■	60 ÷ 204	22,3 ÷ 13,8	
100-315B	-	-	-	-	-	-	-	■	■	72 ÷ 216	31,4 ÷ 17,9	
100-315A	-	-	-	-	-	-	-	■	■	72 ÷ 216	36,5 ÷ 23,1	
100-400C	-	-	-	-	-	-	-	■	■	84 ÷ 228	40,6 ÷ 25,8	
100-400B	-	-	-	-	-	-	-	■	■	84 ÷ 240	48,7 ÷ 31,6	
100-400A	-	-	-	-	-	-	-	■	■	84 ÷ 252	56 ÷ 36,7	
125-250B	-	-	-	-	-	-	-	■	■	102 ÷ 252	20,2 ÷ 11,1	
125-250A	-	-	-	-	-	-	-	■	■	102 ÷ 276	24 ÷ 14,7	
125-315C	-	-	-	-	-	-	-	■	■	120 ÷ 348	25,8 ÷ 15,7	
125-315B	-	-	-	-	-	-	-	■	■	120 ÷ 372	33 ÷ 22,2	
125-315A	-	-	-	-	-	-	-	■	■	120 ÷ 372	39,6 ÷ 28,2	
125-400C	-	-	-	-	-	-	-	■	■	120 ÷ 372	47,6 ÷ 33,8	
125-400B	-	-	-	-	-	-	-	■	■	120 ÷ 396	54,5 ÷ 39,1	
125-400A	-	-	-	-	-	-	-	■	■	120 ÷ 396	59,5 ÷ 45	
150-315D	-	-	-	-	-	-	-	■	■	144 ÷ 444	28,3 ÷ 19,6	
150-315C	-	-	-	-	-	-	-	■	■	144 ÷ 492	32,2 ÷ 21,8	
150-315B	-	-	-	-	-	-	-	■	■	144 ÷ 540	36,3 ÷ 23,6	
150-315A	-	-	-	-	-	-	-	■	■	144 ÷ 564	41 ÷ 27,2	
150-400C	-	-	-	-	-	-	-	■	■	168 ÷ 564	47,8 ÷ 28,7	
150-400B	-	-	-	-	-	-	-	■	■	168 ÷ 588	54,4 ÷ 34,3	
150-400A	-	-	-	-	-	-	-	■	■	168 ÷ 612	60,3 ÷ 39,8	
Not envisaged in the EN 733 standard												
200-315D	-	-	-	-	-	-	-	■	■	200 ÷ 800	21,7 ÷ 12,5	
200-315C	-	-	-	-	-	-	-	■	■	200 ÷ 850	26,6 ÷ 14,6	
200-315B	-	-	-	-	-	-	-	■	■	200 ÷ 900	33,4 ÷ 16,7	
200-315A	-	-	-	-	-	-	-	■	■	200 ÷ 900	35,9 ÷ 19,8	
200-400C	-	-	-	-	-	-	-	■	■	200 ÷ 800	44,1 ÷ 31,5	
200-400B	-	-	-	-	-	-	-	■	■	200 ÷ 850	50,8 ÷ 36,6	
200-400A	-	-	-	-	-	-	-	■	■	200 ÷ 900	58,5 ÷ 44	
250-315C	-	-	-	-	-	-	-	■	■	250 ÷ 1100	25,5 ÷ 16,8	
250-315B	-	-	-	-	-	-	-	■	■	250 ÷ 1170	33 ÷ 19	
250-315A	-	-	-	-	-	-	-	■	■	250 ÷ 1200	35 ÷ 20	
250-400D	-	-	-	-	-	-	-	■	■	250 ÷ 1300	39,9 ÷ 24,3	
250-400C	-	-	-	-	-	-	-	■	■	250 ÷ 1400	45,8 ÷ 27,4	
250-400B	-	-	-	-	-	-	-	■	■	250 ÷ 1500	51,7 ÷ 30,3	
250-400A	-	-	-	-	-	-	-	■	■	250 ÷ 1600	57,4 ÷ 31,7	

MN Series

Models list and materials

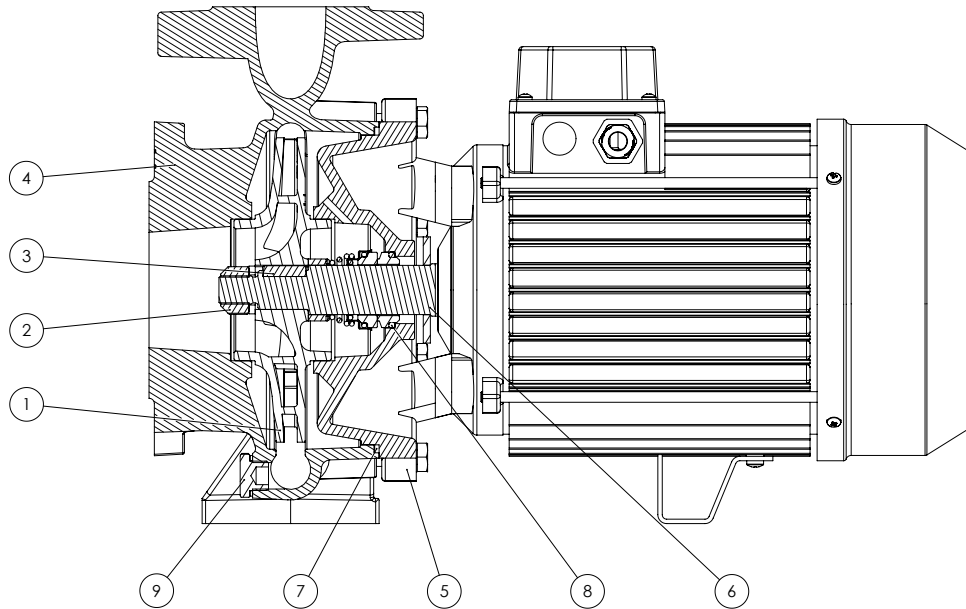

POS: N.	DENOMINATION	VERSION	MATERIAL	REFERENCE STANDARDS	
				EUROPE	USA
1	Impeller	Standard B X	Cast iron G20 Bronze Stainless steel	GJL-200 (JL1030) CuSn10-C (CC480K) X5CrNiMo17-12-2/ 1.4401	ASTM Class 30 UNS C90700 AISI 316
2	Impeller lock nut and washer		Stainless steel	X5CrNiMo17-12-2/ 1.4401	AISI 316
3	Impeller key		Stainless steel	X5CrNiMo17-12-2/ 1.4401	AISI 316
4	Volute casing	Standard for models up to 80-200 Standard from model 80-250	Cast iron G20 Cast iron G25	GJL-200 (JL1030) GJL-250 (JL1040)	ASTM Class 30 ASTM Class 35
5	Motor bracket		Cast iron G20	GJL-200 (JL1030)	ASTM Class 30
6	Shaft extension		Stainless steel	X5CrNi18-10/ 1.4301	AISI 304
7	O-ring	Standard E V	NBR EPDM FKM		
8	Mechanical seal		(Search for the material in the mechanical seal table)		
9	Fill and drain plugs		Brass	CU ZN 40 PB2 UNI 5705/65	C37700

TYPE	P2		1~		3~		Q (m³/h - l/min)														
			P ₁ max kW	A 1-230V 50Hz	P ₁ max kW	A 3-400V 50Hz	0	6	7,5	9	12	15	18	21	24	27	30	33			
	HP	kW	H (m)																		
32-160C	2	1,5	2,0	9,3	1,9	3,6	23,0	22,8	22,5	22,0	21,0	19,2	16,9	14,0							
32-160B	3	2,2	2,7	12,4	2,6	4,9	28,0	27,7	27,4	27,0	26,2	24,9	22,9	20,1	17,0						
32-160A	4	3	-	-	3,8	6,8	36,1	36,2	36,0	35,6	34,6	33,2	31,4	28,9	25,7	22,1					
32-200C	5,5	4	5,2	22,9	4,9	8,9	40,2	40,3	40,1	39,8	38,9	37,7	36,1	34,2	31,6	28,7					
32-200B1	7,5	5,5	-	-	6,4	11,3	48,3	48,0	47,9	47,6	46,7	45,5	44,2	42,6	40,5	37,9					
32-200B	7,5	5,5	-	-	6,7	11,1	48,3	48,0	47,9	47,6	46,7	45,5	44,2	42,6	40,5	37,9	35,4				
32-200A1	10	7,5	-	-	8,2	14,5	57,9	58,3	58,4	58,4	58,0	57,1	55,6	53,8	51,4	49,2	46,6				
32-200A	10	7,5	-	-	8,6	14,1	57,9	58,3	58,4	58,4	58,0	57,1	55,6	53,8	51,4	49,2	46,6	44,3			
32-250C	12,5	9,2	-	-	10,0	16,8	74,6		72,8	72,5	71,9	70,5	68,8	66,6	64,1	61,3					
32-250B	15	11	-	-	12,2	20,0	84,8		84,0	83,9	83,6	82,7	81,1	78,6	75,4	73,2					
32-250A1	20	15	-	-	13,5	23,2	93,5		93,6	93,7	93,7	93,4	92,3	90,4	87,7	85,3					
32-250A	20	15	-	-	13,5	23,2	93,5		93,6	93,7	93,7	93,4	92,3	90,4	87,7	85,3					

TYPE	P2		1~		3~		Q (m³/h - l/min)																			
			P ₁ max kW	A 1-230V 50Hz	P ₁ max kW	A 3-400V 50Hz	0	9	12	15	18	21	24	27	30	33	36	39	42	45	48	54	60			
	HP	kW	H (m)																							
40-125C	2	1,5	2,0	9,3	1,9	3,6	17,9	18,5	18,4	18,1	17,5	16,6	15,6	14,3	12,8	11,1	9,4									
40-125B	3	2,2	2,7	12,4	2,6	4,9	22,6	23,4	23,3	23,1	22,7	22,0	21,0	19,9	18,6	17,0	15,1	13,2								
40-125A	4	3	-	-	3,6	6,5	26,8	27,6	27,7	27,6	27,2	26,5	25,7	24,6	23,4	22,0	20,3	18,5	16,8							
40-160B	4	3	3,8	16,7	3,8	6,8	28,2	29,2	29,2	28,9	28,3	27,5	26,5	25,3	23,8	22,3	20,5									
40-160A	5,5	4	5,0	22,5	4,9	8,8	33,8	34,9	34,8	34,5	33,9	33,2	32,4	31,3	30,0	28,5	26,9	25,2	23,4							
40-160AP	7,5	5,5	-	-	6,1	11,0	38,6	39,8	39,9	39,8	39,4	38,7	37,9	37,0	35,8	34,4	32,9	31,1	29,3	27,4	25,3					
40-200B1	7,5	5,5	-	-	6,8	12,0	44,7	45,5	45,4	45,0	44,5	43,5	42,3	41,0	39,3	37,2	34,9	32,3								
40-200B	7,5	5,5	-	-	6,9	11,4	44,6	45,5	45,4	45,0	44,5	43,5	42,3	41,0	39,3	37,2	34,9	32,3	29,4							
40-200A1	10	7,5	-	-	9,0	15,5	56,2	56,5	56,5	56,3	55,9	55,1	54,1	52,8	51,2	49,3	47,0	44,4								
40-200A	10	7,5	-	-	9,3	15,1	56,2	56,5	56,5	56,3	55,9	55,1	54,1	52,8	51,2	49,3	47,0	44,4	41,6							
40-200AP	12,5	9,2	-	-	10,2	16,8	61,7	61,4	61,2	60,8	60,0	59,1	57,9	56,4	54,7	53,1	51,1	48,5	45,5	42,2						
40-250C	12,5	9,2	-	-	11,1	18,0	64,8	64,4	64,2	63,8	63,4	62,7	61,9	61,0	59,8	57,9	55,4									
40-250B	15	11	-	-	13,8	22,3	73,7	73,9	74,5	73,2	71,9	71,1	70,2	69,2	68,1	66,7	64,7	62,1								
40-250A1	20	15	-	-	16,5	27,2	82,6	84,6	84,8	84,7	84,3	83,4	82,4	81,3	80,0	78,5	76,9	75,4	72,8							
40-250A	20	15	-	-	17,5	29,1	82,6	84,6	84,8	84,7	84,3	83,4	82,4	81,3	80,0	78,5	76,9	75,4	72,8	69,0						
40-250BM max 14 bar	25	18,5	-	-	20,6	34,1	92,6	93,2	93,3	93,2	93,1	92,8	92,4	91,7	90,9	89,8	88,3	86,5	84,6	82,3	79,5	72,0				
40-250AM max 14 bar	30	22	-	-	24,4	40,3	101,7	103,0	102,8	102,3	102,0	101,7	101,2	100,4	99,4	98,1	96,5	94,8	93,1	90,9	85,0	77,5				

TYPE	P2		1~		3~		Q (m³/h - l/min)																			
			P ₁ max kW	A 1-230V 50Hz	P ₁ max kW	A 3-400V 50Hz	0	12	15	18	21	24	27	30	33	36	39	42	45	48	54	60	66	72	78	
	HP	kW	H (m)																							
50-125B	4	3	3,6	16,1	3,8	6,8	20,0	20,6	20,6	20,4	20,3	20,1	19,9	19,6	19,2	18,7	18,2	17,6	17,0	16,4	15,0	13,2	11,3	9,2		
50-125A	5,5	4	5,0	22,5	4,8	8,8	23,7	24,3	24,3	24,2	24,1	23,9	23,7	23,3	23,0	22,6	22,1	21,7	21,2	20,7	19,6	18,2	16,4	14,2		
50-160B1	7,5	5,5	-	-	6,5	11,4	32,1				33,5	33,4	33,1	32,7	32,2	31,6	31,0	30,2	29,1	28,3	26,2	23,9	21,5			
50-160B	7,5	5,5	-	-	6,5	10,9	32,1				33,5	33,4	33,1	32,7	32,2	31,6	31,0	30,2	29,1	28,3	26,2	23,9	21,5	18,9		
50-160A1	10	7,5	-	-	8,6	15,1	38,1				39,8	39,8	39,7	39,5	39,2	38,8	38,3	37,7	36,7	36,0	34,2	32,2	29,7	27,4		
50-160A	10	7,5	-	-	8,8	14,4	38,1				39,8	39,8	39,7	39,5	39,2	38,8	38,3	37,7	36,7	36,0	34,2	32,2	29,7	27,4	25,4	
50-200C	12,5	9,2	-	-	10,4	17,2	48,2					49,7	49,2	48,5	47,7	46,9	45,9	44,9	43,7	42,6	40,0	36,0	32,3	28,9		
50-200B	15	11	-	-	11,9	19,5	53,1					54,6	54,1	53,5	52,9	52,2	51,4	50,4	49,3	48,1	45,5	42,7	38,8	35,0		
50-200A1	20	15	-	-	14,6	24,7	59,9					61,8	61,5	61,0	60,4	59,7	58,8	58,0	57,1	56,0	53,6	50,8	47,8	44,4	39,8	
50-200A	20	15	-	-	14,6	24,7	59,9					61,8	61,5	61,0	60,4	59,7	58,8	58,0	57,1	56,0	53,6	50,8	47,8	44,4	39,8	
50-250C1	20	15	-	-	16,1	26,6	69,2						68,2	67,7	67,0	66,3	65,6	64,7	63,8	62,8	59,9	56,2				
50-250C	20	15	-	-	17,2	28,6	69,2						68,2	67,7	67,0	66,3	65,6	64,7	63,8	62,8	59,9	56,2	52,1			
50-250B	25	18,5	-	-	20,7	34,3	78,8						78,4	78,0	77,6	77,0	76,1	75,1	74,0	72,9	70,3	66,9	62,9	58,5		
50-250A	30	22	-	-	24,8	40,9	88,5						88,3	88,1	87,7	87,2	86,6	85,8	84,8	83,8	81,4	78,5	75,0	70,2	64,8	

TYPE	P2		3-		Q (m ³ /h - l/min)																				
			P ₁ max kW	A 3-400V 50Hz	0	30	33	36	39	42	45	48	54	60	66	72	78	84	96	108	120	132	138	144	150
	HP	kW	H (m)																						
65-125B1	7,5	5,5	6,4	11,3	19,7	20,6	20,5	20,4	20,4	20,3	20,2	20,2	20,0	19,7	19,3	18,8	18,2	17,5	16,3	15,0					
65-125B	7,5	5,5	6,6	11,0	19,7	20,6	20,5	20,4	20,4	20,3	20,2	20,2	20,0	19,7	19,3	18,8	18,2	17,5	16,3	15,0	13,1				
65-125A1	10	7,5	8,6	15,1	24,6	25,2	25,2	25,1	25,1	25,0	24,8	24,9	24,7	24,5	24,2	23,9	23,5	23,0	22,0	20,6	18,8				
65-125A	10	7,5	8,8	14,4	24,6	25,2	25,2	25,1	25,1	25,0	24,9	24,9	24,7	24,5	24,2	23,9	23,5	23,0	22,0	20,6	18,8	16,8			
65-160C	12,5	9,2	10,1	16,8	28,9					30,6	30,5	30,3	30,0	29,6	29,1	28,5	27,9	27,2	25,3	22,9	20,2	17,5	16,0	13,9	
65-160B	15	11	12,7	20,6	33,2					35,1	35,0	34,9	34,6	34,3	33,8	33,3	32,8	32,1	30,4	28,2	25,5	22,5	21,4	20,4	
65-160A1	20	15	16,8	27,6	40,1					42,5	42,5	42,5	42,3	42,1	41,8	41,4	41,0	40,4	38,9	37,1	35,3	32,8	31,7		
65-160A	20	15	17,1	28,5	40,1					42,5	42,5	42,5	42,3	42,1	41,8	41,4	41,0	40,4	38,9	37,1	35,3	32,8	31,7	30,9	
65-200C1	20	15	16,8	27,6	44,4								46,1	45,4	44,7	44,0	43,2	42,4	40,3	37,5	33,7	28,9			
65-200C	20	15	17,0	28,3	44,4								46,1	45,4	44,7	44,0	43,2	42,4	40,3	37,5	33,7	28,9	26,8		
65-200B	25	18,5	21,2	34,8	51,7								53,9	53,4	52,7	52,0	51,3	50,4	48,6	45,9	43,0	39,4	37,1	34,6	
65-200A	30	22	25,4	41,7	60,3								61,8	61,4	61,0	60,4	59,8	59,1	57,1	54,6	51,6	48,3	46,5	44,4	
65-250B	40	30	30,8	55,3	80,6								80,6	79,5	78,4	77,1	75,7	74,1	70,4	66,1	61,0	54,7	51,0	47,3	
65-250A	50	37	37,0	69,2	91,6								91,6	90,8	89,8	88,6	87,4	85,9	82,5	77,8	72,8	67,4	64,3	60,8	57,9

TYPE	P2		3-		Q (m ³ /h - l/min)																				
			P ₁ max kW	A 3-400V 50Hz	0	66	72	78	84	96	108	120	132	138	144	156	168	180	195	210	225	240			
	HP	kW	H (m)																						
80-160E	12,5	9,2	9,8	16,3	21,5	22,9	22,5	22,1	21,6	20,8	19,9	18,9	17,7	17,2	16,6	15,3	13,7								
80-160D	15	11	12,2	20,0	25,4	27,3	27,0	26,6	26,3	25,4	24,5	23,5	22,4	21,8	21,2	19,9	18,3	16,4							
80-160C1	20	15	14,5	24,5	29,0	30,9	30,7	30,4	30,1	29,4	28,5	27,4	26,3	25,8	25,3	24,1	22,5	20,7	18,4						
80-160C	20	15	14,5	24,5	29,0	30,9	30,7	30,4	30,1	29,4	28,5	27,4	26,3	25,8	25,3	24,1	22,5	20,7	18,4						
80-160B	25	18,5	18,1	30,3	33,6	35,9	35,7	35,4	35,2	34,5	33,7	32,9	32,0	31,6	31,1	30,0	28,6	27,0	24,5	22,0					
80-160A	30	22	22	37	38	40,5	40,4	40,2	40,1	39,6	39,1	38,4	37,5	37,1	36,6	35,4	34,1	32,6	30,4	28,3	23,9				
80-200B	40	30	32,0	57,2	50,4				54,5	53,9	53,2	52,3	51,3	50,7	50,2	48,9	47,4	45,8	43,4	40,9	38,5				
80-200A	50	37	38,6	71,6	57,3				61,7	61,3	60,6	59,4	58,2	57,8	57,5	56,8	55,4	53,7	51,5	49,1	46,6	43,9			

TYPE	P2		3-		Q (m ³ /h - l/min)																				
			P ₁ max kW	A 3-400V 50Hz	0	96	108	120	132	138	144	156	168	180	195	210	225	240	270	300	330				
	HP	kW	H (m)																						
100-160B	40	30	31,9	57,1	41,7	40,7	40,8	40,7	40,4	40,3	40,1	39,6	39,1	38,5	37,8	37,0	36,1	35,0	32,3	29,2	25,7				
100-160A	50	37	37,5	70,2	46,0	45,1	45,2	45,1	44,9	44,8	44,7	44,3	43,9	43,3	42,7	42,0	41,1	40,2	37,9	35,0	31,9				

MN-MNG-MNGX-MA-MAX ~ EN 733

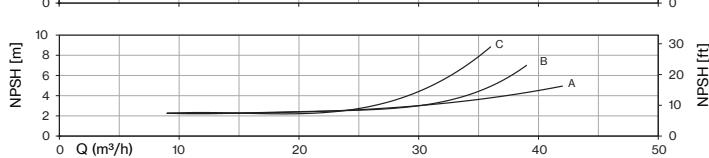
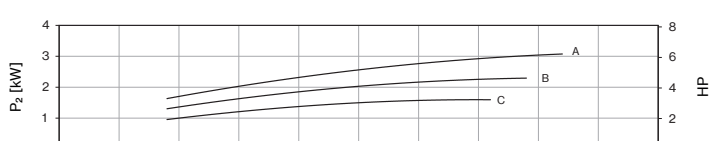
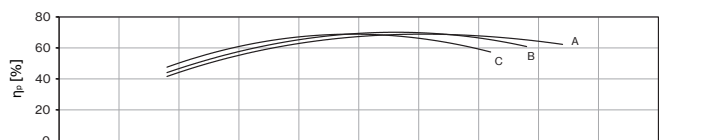
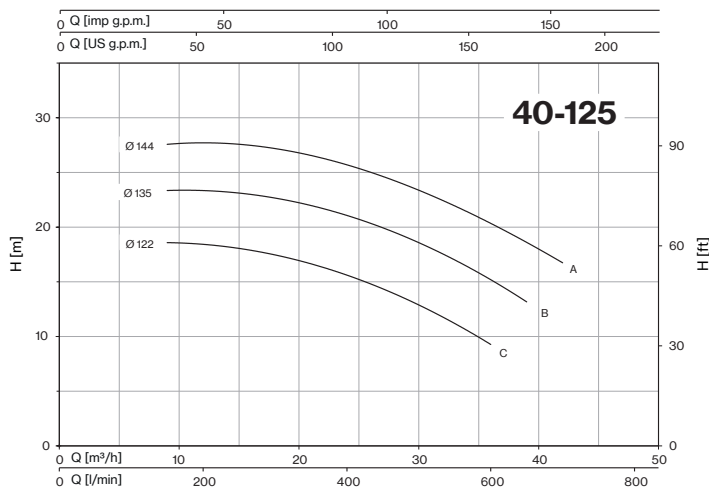
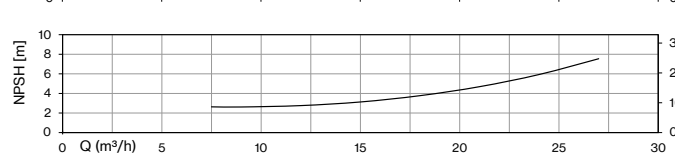
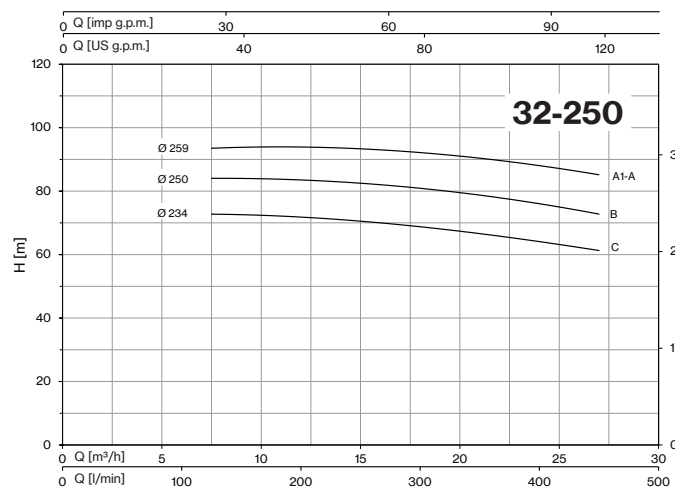
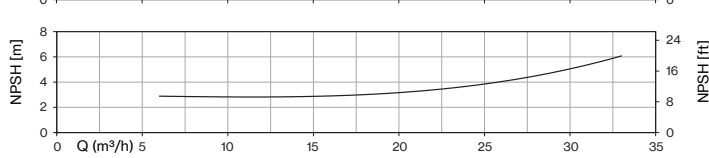
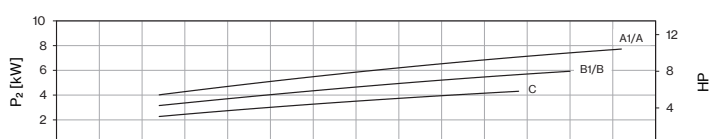
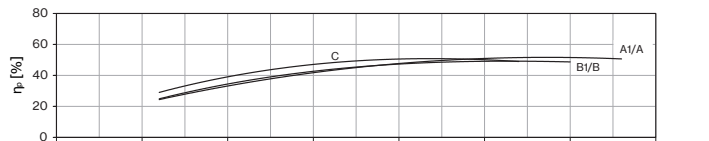
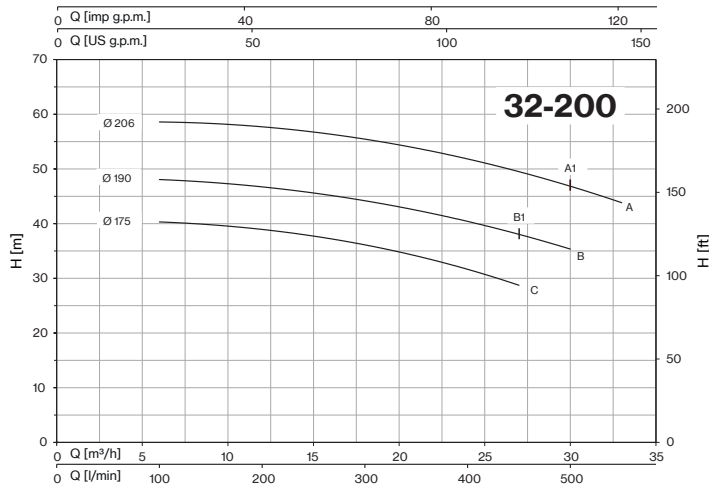
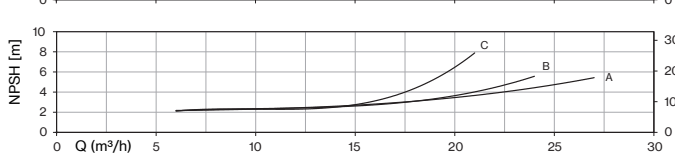
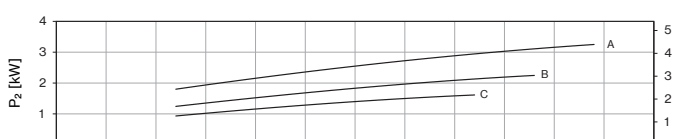
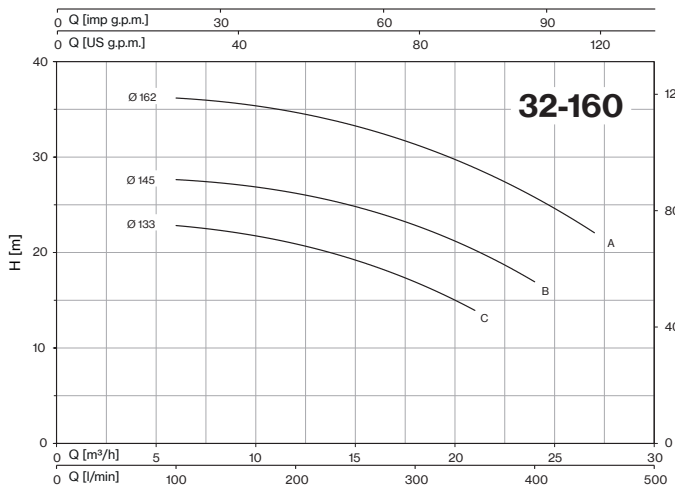

MN-MNG-MNGX-MA-MAX ~ EN 733

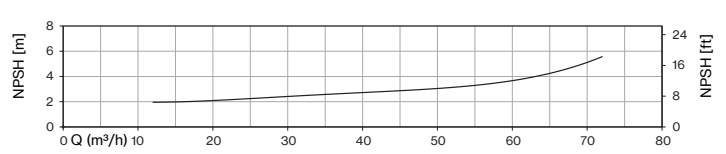
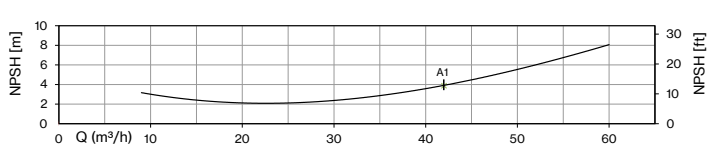
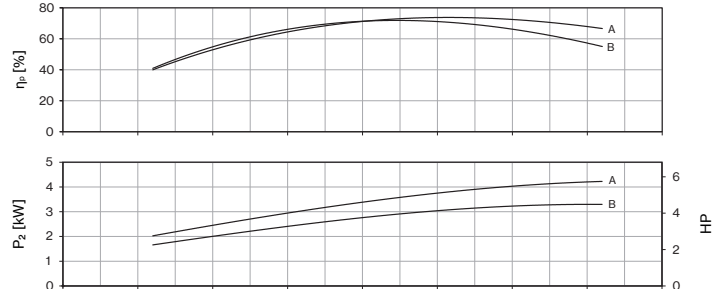
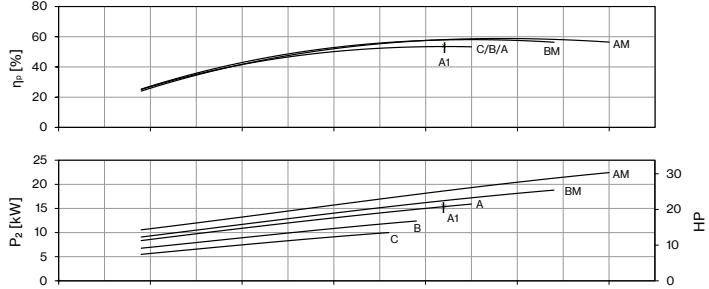
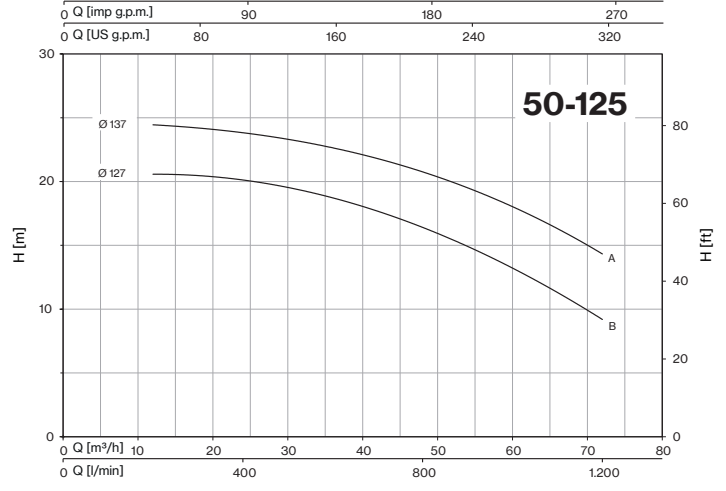
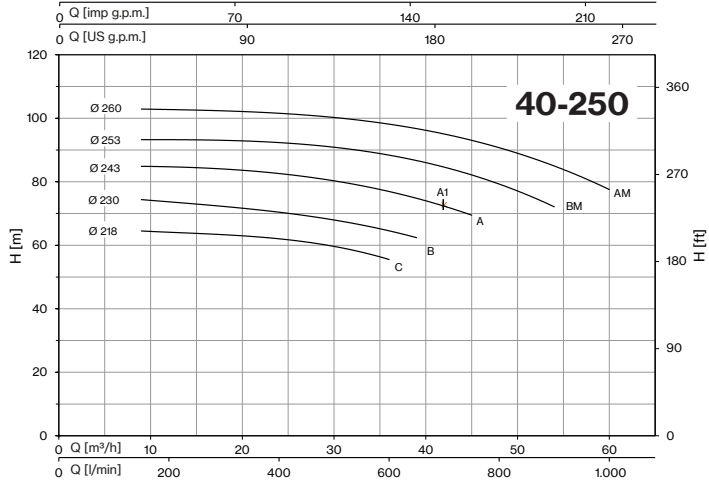
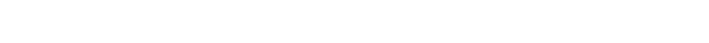
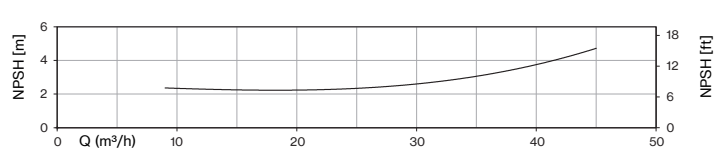
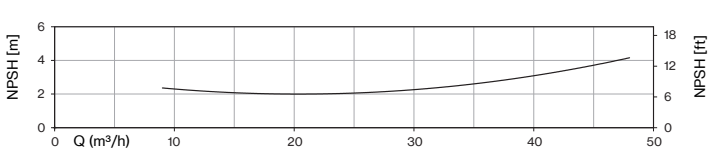
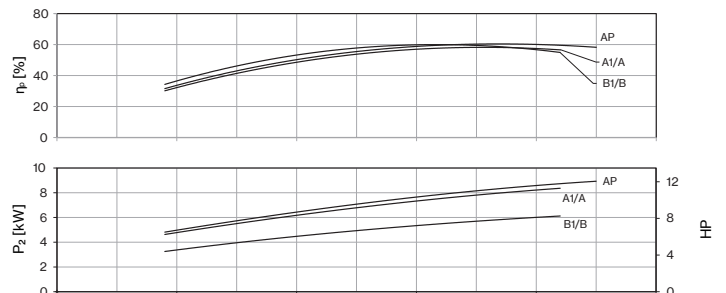
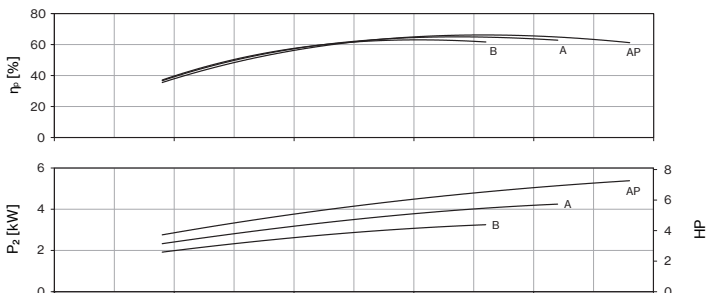
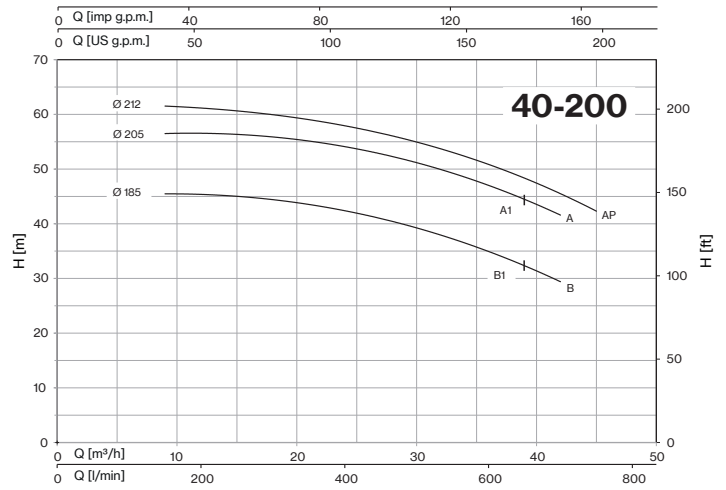
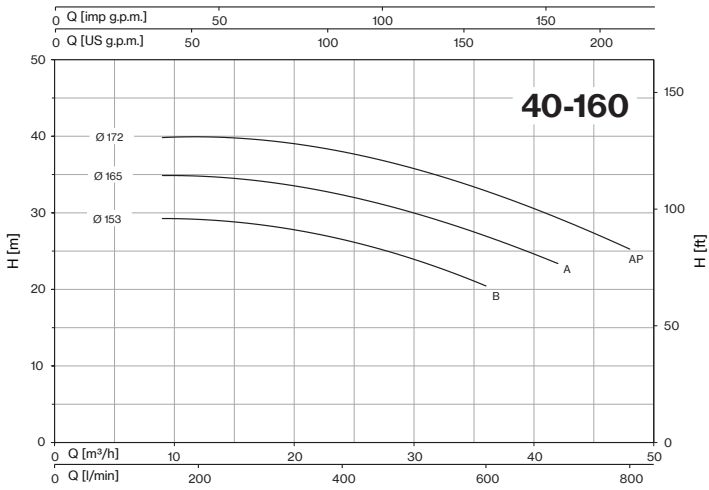

MN-MNG-MNGX-MA-MAX ~ EN 733

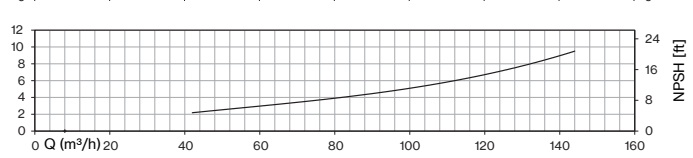
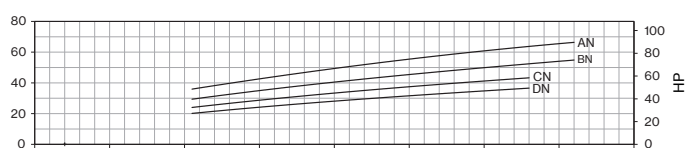
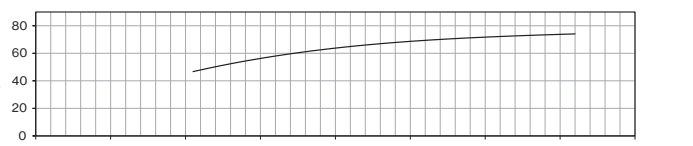
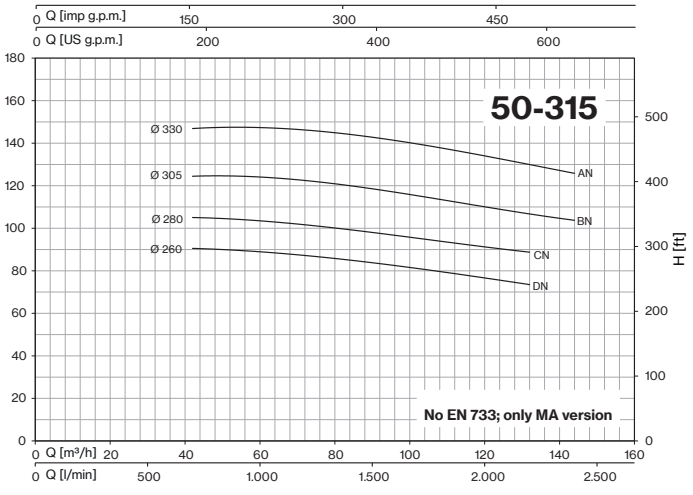
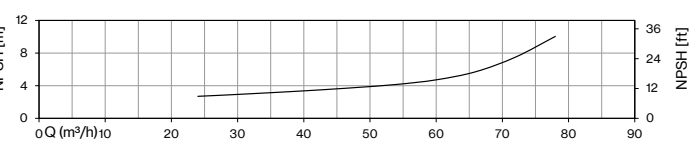
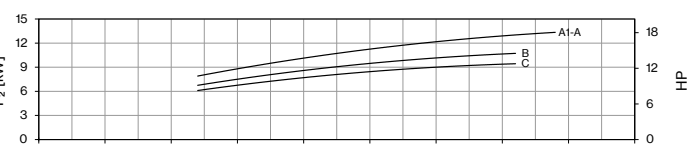
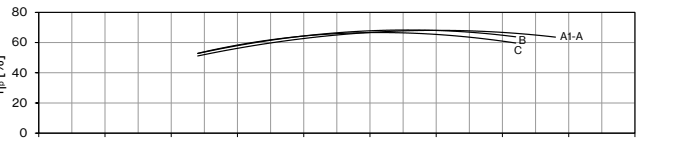
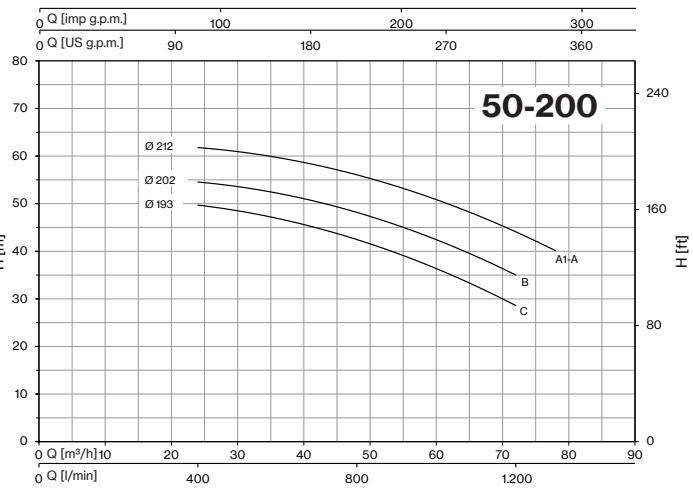
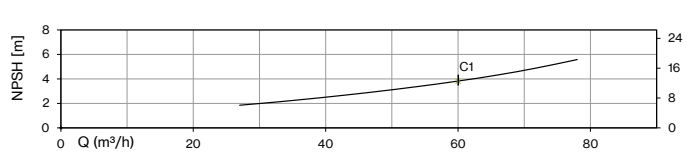
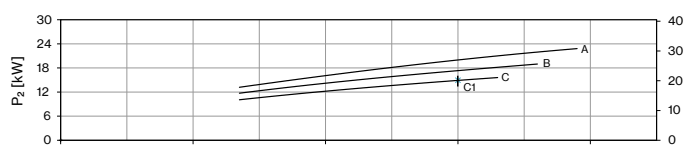
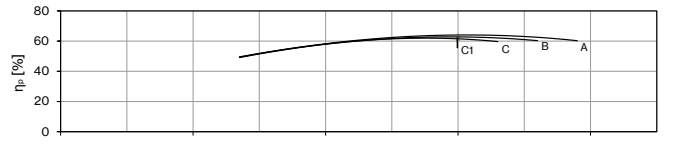
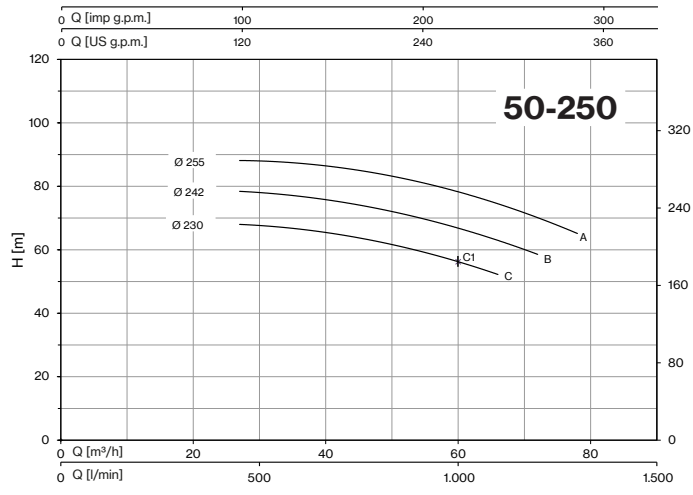
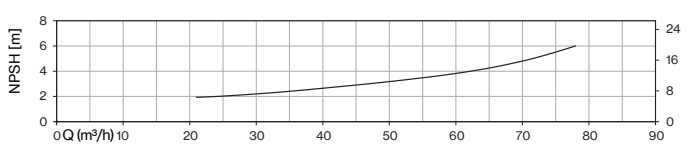
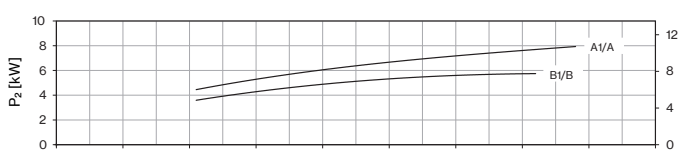
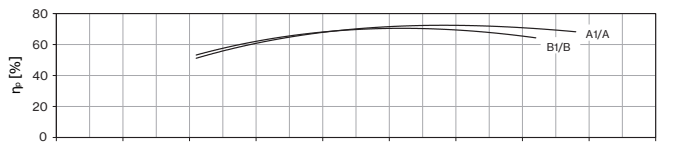
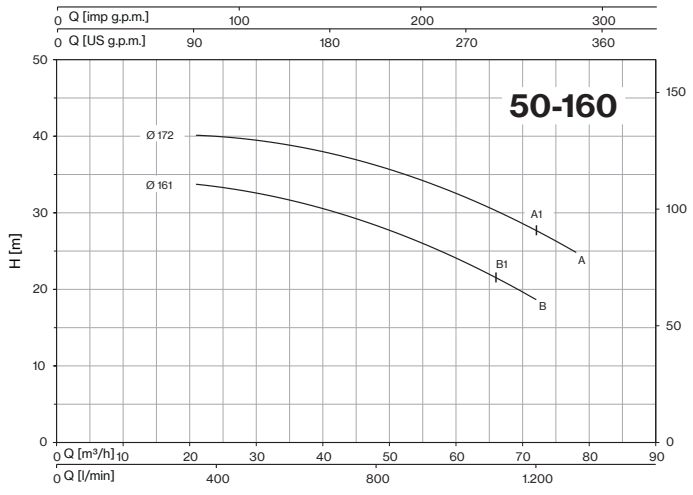

MN-MNG-MNGX-MA-MAX ~ EN 733

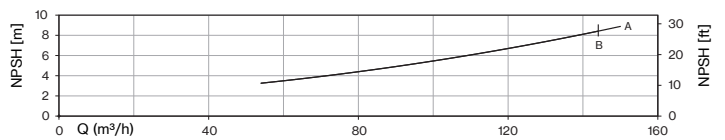
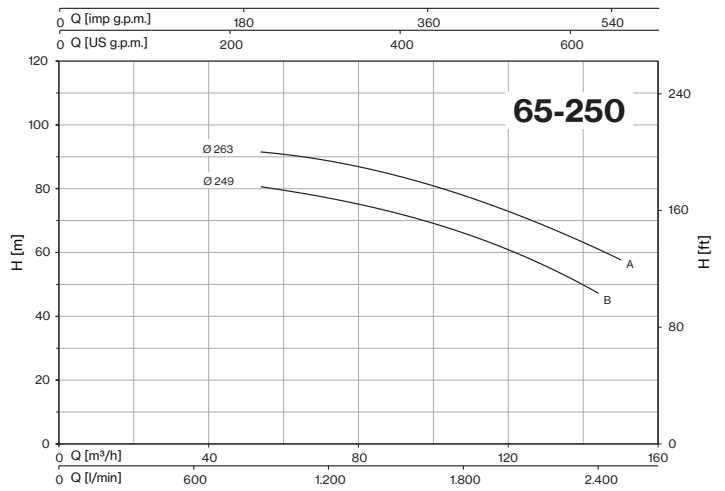
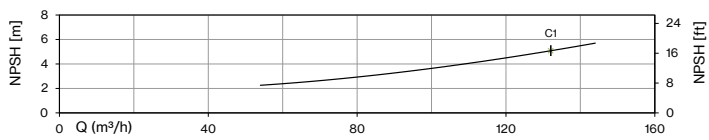
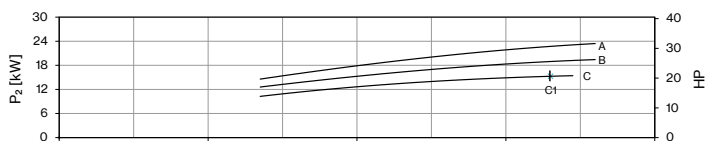
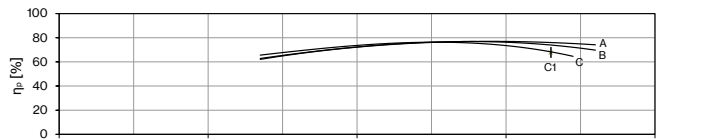
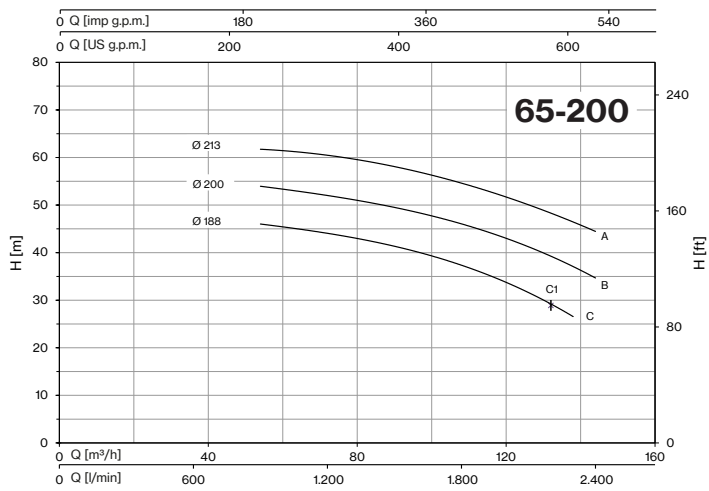
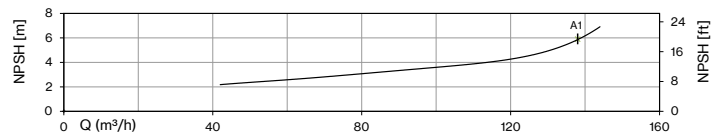
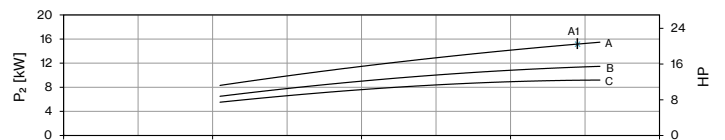
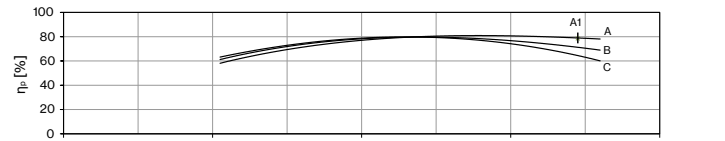
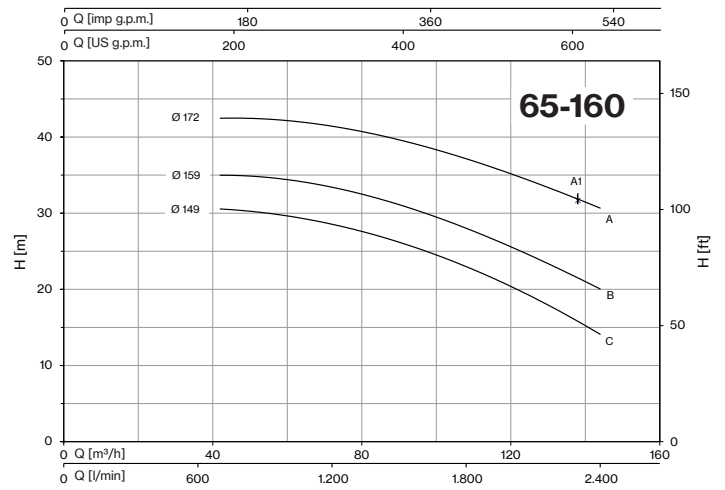
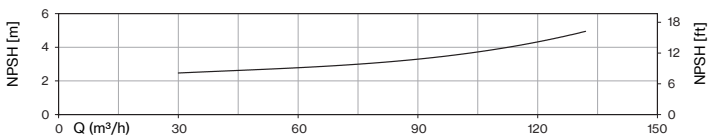
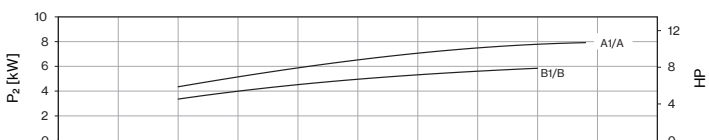
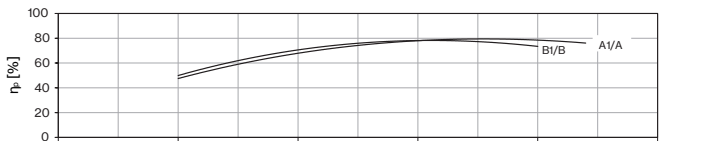
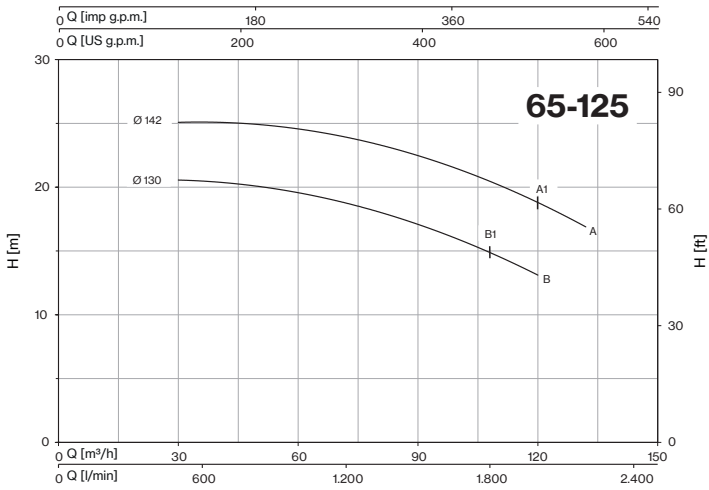

MN-MNG-MNGX-MA-MAX ~ EN 733

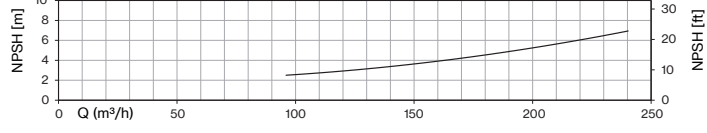
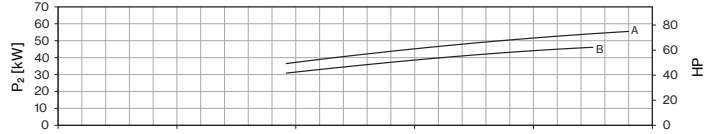
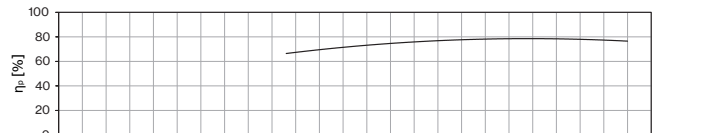
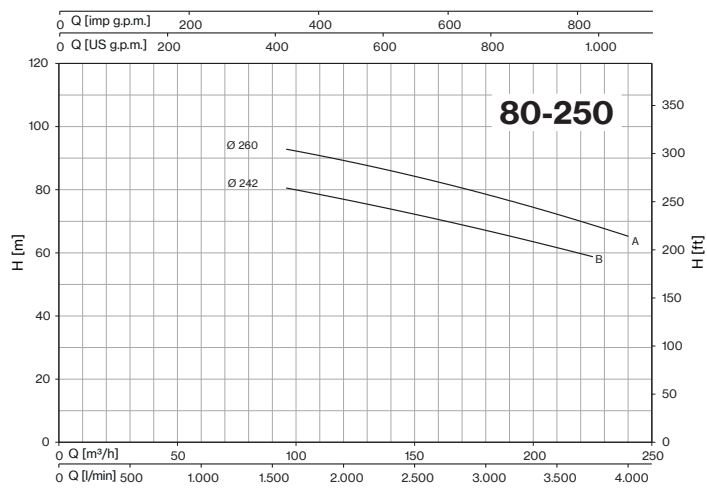
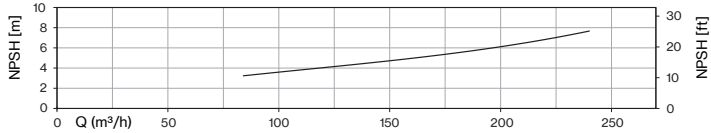
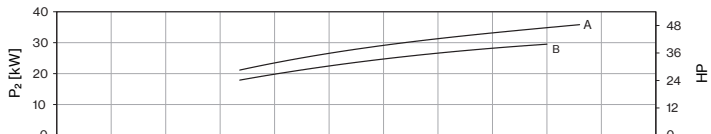
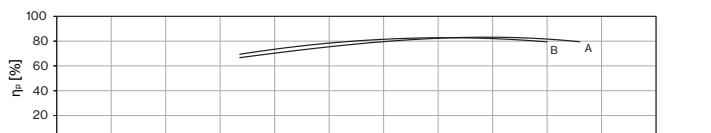
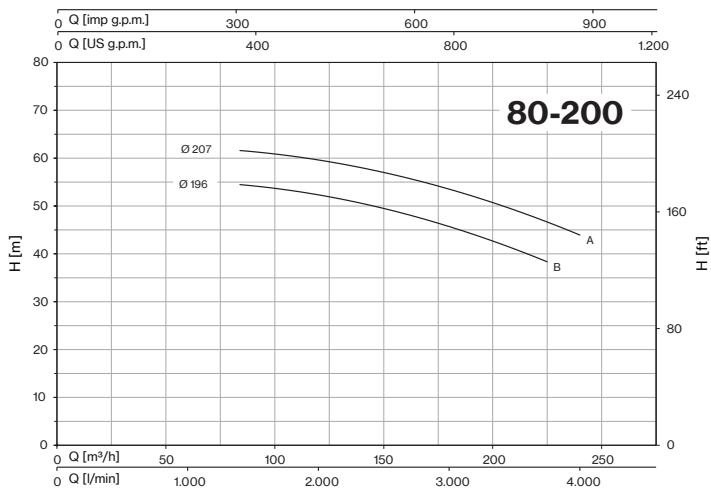
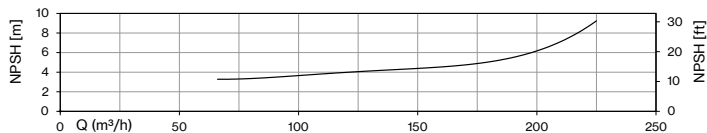
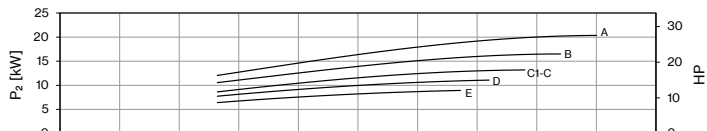
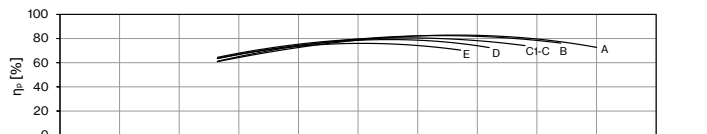
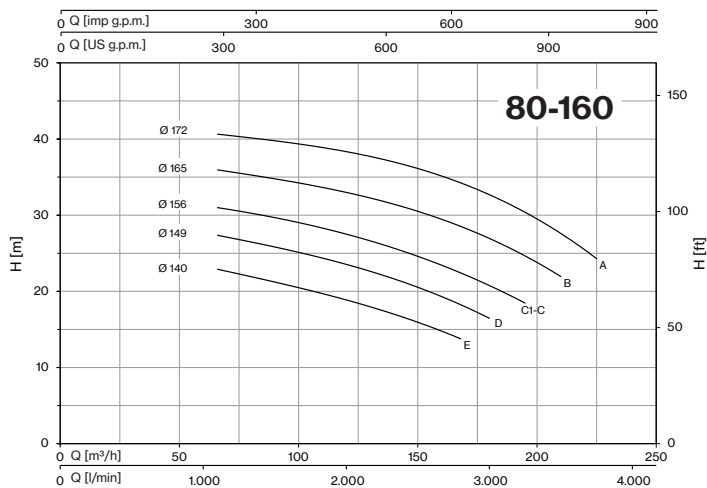
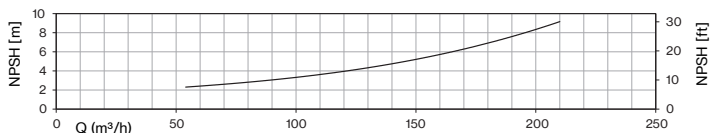
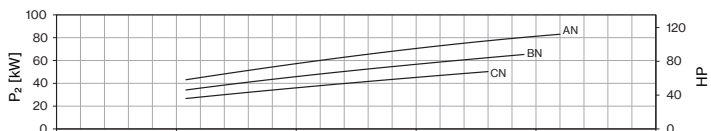
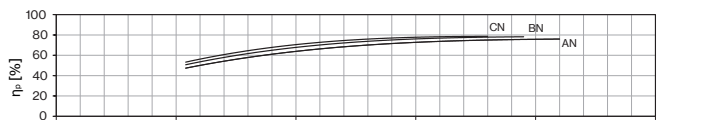
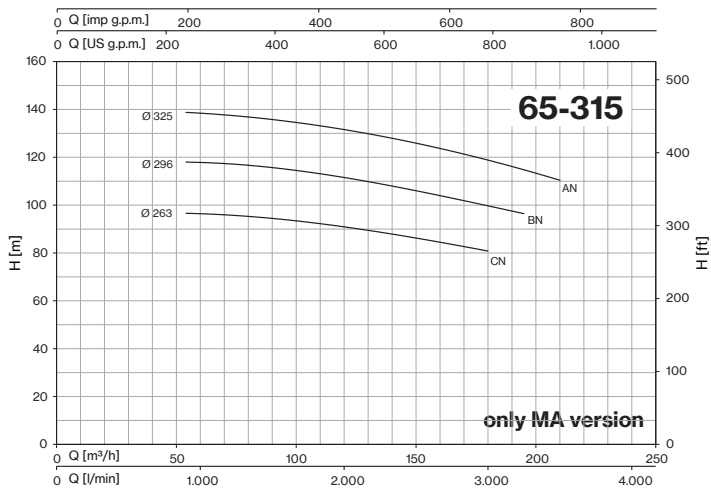

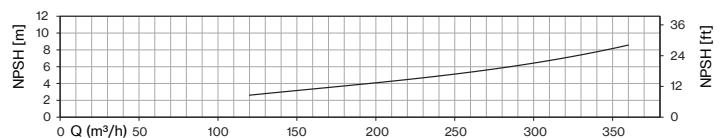
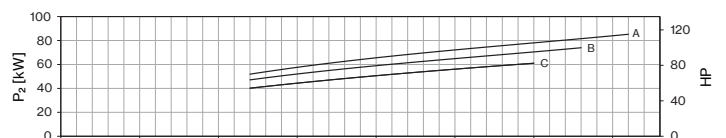
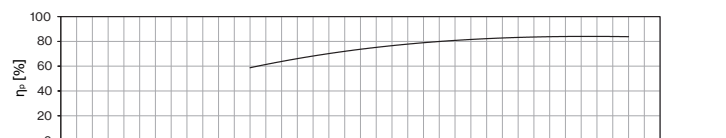
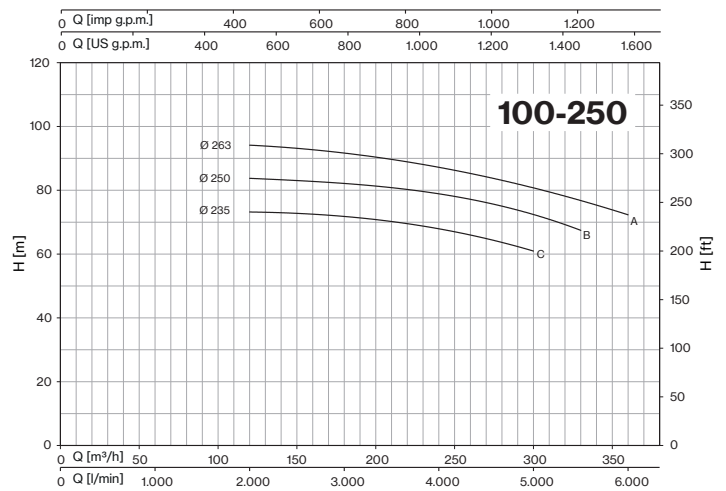
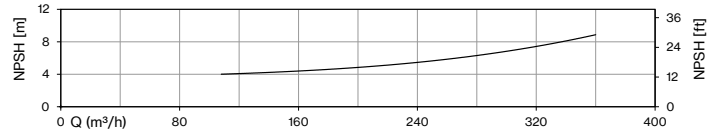
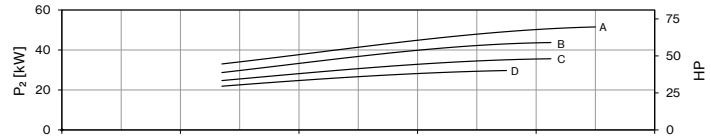
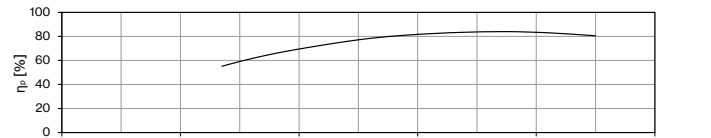
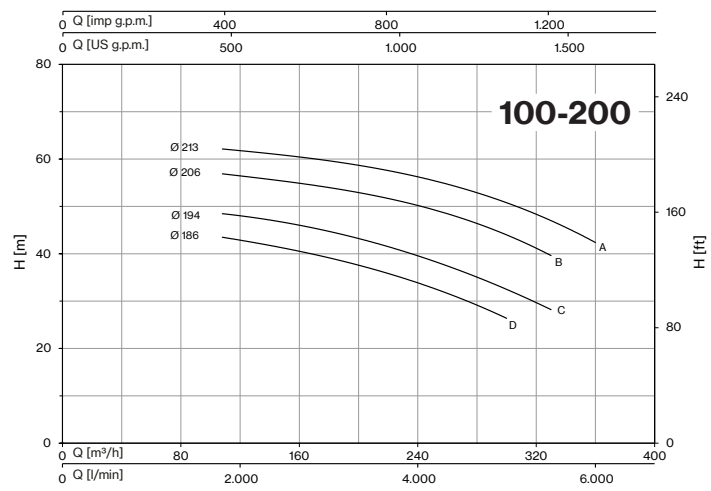
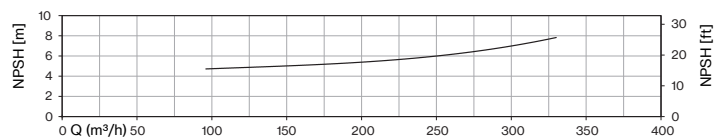
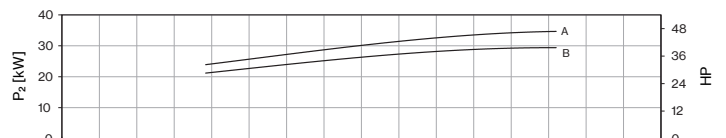
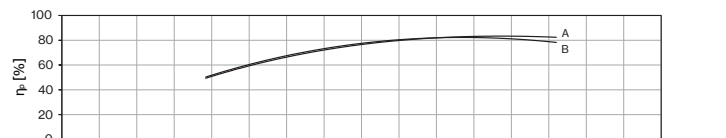
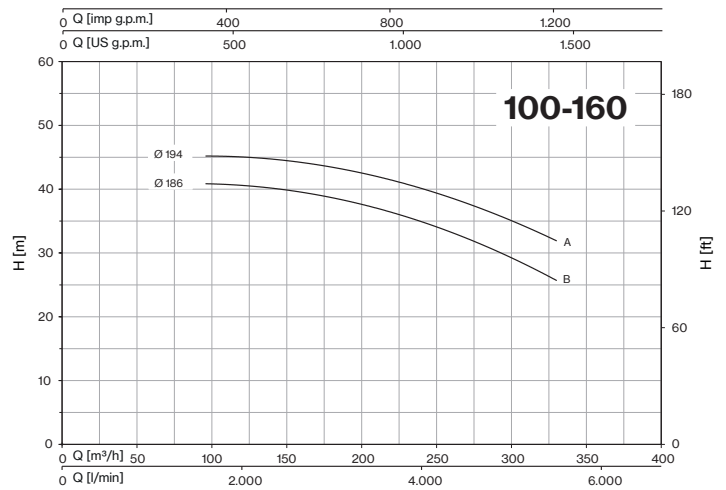
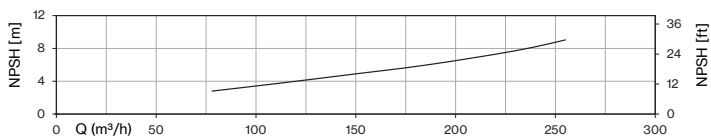
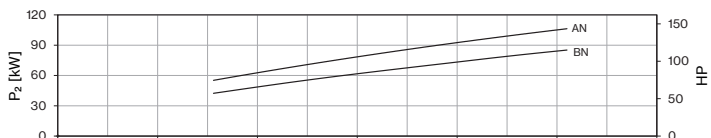
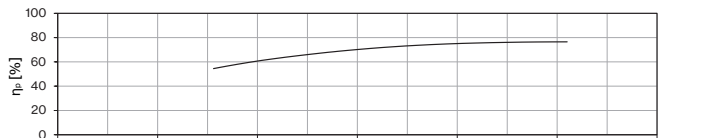
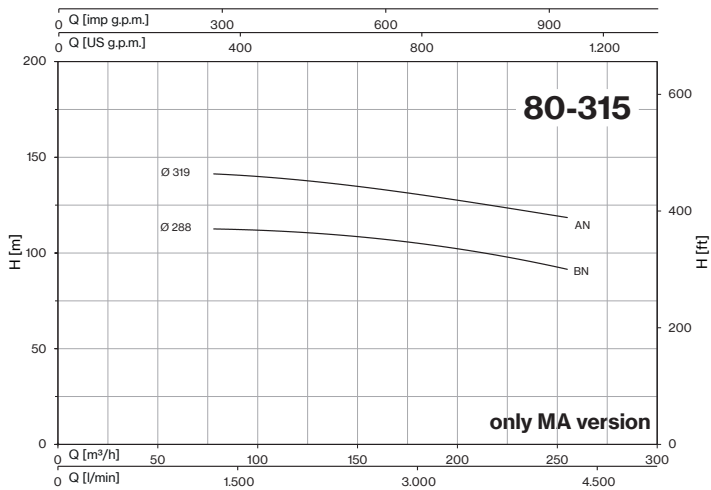

MN-MNG-MNGX-MA-MAX ~ EN 733

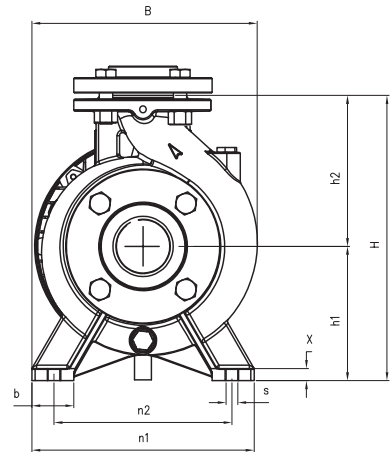
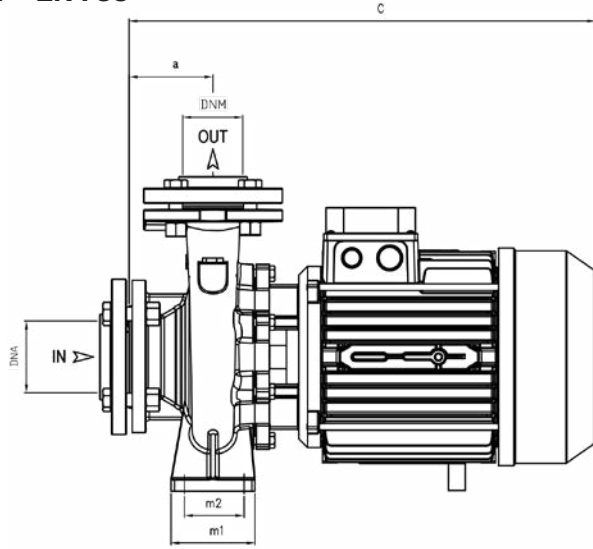

MN ~ EN 733



MEC	3~ TYPE	1~ TYPE	DIMENSIONS (mm)																	M	Kg
			DNA	DNM	a	h1	h2	m1	m2	n1	n2	b	x	s	C	B	H	I	L		
90	32-160 C	32-160 C	50	32	80	132	160	100	70	240	190	50	12	14	530	240	292	551	250	341	41
90	32-160 B	32-160 B			80	132	160	100	70	240	190	50	12	14	530	240	292	551	250	341	44
90	32-160 A				80	132	160	100	70	240	190	50	12	14	530	240	292	551	250	341	47
112		32-200 C			80	160	180	100	70	240	190	50	12	14	574	268	340	602	263	395	65,5
100	32-200 C				80	160	180	100	70	240	190	50	12	14	540	268	340	602	263	395	56,5
112	32-200 B1				80	160	180	100	70	240	190	50	12	14	520	268	340	627	287	408	65,5
132	32-200 B				80	160	180	100	70	240	190	50	12	14	565	268	340	627	287	408	72
112	32-200 A1				80	160	180	100	70	240	190	50	12	14	520	268	340	627	287	408	72
132	32-200 A				80	160	180	100	70	240	190	50	12	14	565	268	340	627	287	408	79
132	32-250 C				100	180	225	125	95	320	250	65	12	14	625	305	405	666	346	471	101,5
132	32-250 B				100	180	225	125	95	320	250	65	14	14	625	305	405	666	346	471	105,5
132	32-250 A1				100	180	225	125	95	320	250	65	14	14	670	305	405	810	354	480	110
160	32-250 A				100	180	225	125	95	320	250	65	14	14	695	305	405	810	354	480	135,5
90	40-125 C	40-125 C			65	40	80	112	140	100	70	210	160	50	12	14	535	220	252	551	250
90	40-125 B	40-125 B	80	112			140	100	70	210	160	50	12	14	535	220	252	551	250	341	44
90	40-125 A		80	112			140	100	70	210	160	50	12	14	535	220	252	551	250	341	47,5
100		40-160 B	80	132			160	100	70	240	190	50	12	14	535	245	292	551	250	341	56
100	40-160 B		80	132			160	100	70	240	190	50	12	14	535	245	292	551	250	341	52
112		40-160 A	80	132			160	100	70	240	190	50	15	14	579	245	292	602	263	395	64,5
100	40-160 A		80	132			160	100	70	240	190	50	15	14	535	245	292	602	263	395	56,5
112	40-160 AP		80	132			160	100	70	240	190	50	15	14	579	245	292	627	287	408	63
112	40-200 B1		100	160			180	100	70	265	212	50	15	14	597	273	340	627	287	408	68
132	40-200 B		100	160			180	100	70	265	212	50	15	14	590	273	340	627	287	408	74,5
112	40-200 A1		100	160			180	100	70	265	212	50	15	14	597	273	340	627	287	408	74
132	40-200 A		100	160			180	100	70	265	212	50	15	14	590	273	340	627	287	408	81
132	40-200 AP		100	160			180	100	70	265	212	50	15	14	628	273	340	666	346	471	93,5
132	40-250 C		100	180			225	125	95	320	250	65	15	14	630	322	405	666	346	471	100,5
132	40-250 B		100	180	225	125	95	320	250	65	15	14	630	322	405	666	346	471	105		
132	40-250 A1		100	180	225	125	95	320	250	65	15	14	675	322	405	810	354	480	109,5		
160	40-250 A		100	180	225	125	95	320	250	65	15	14	700	322	405	810	354	480	135		
132	40-250 BM		100	180	225	125	95	320	250	65	15	14	750	332	405	810	354	480	150		
160	40-250 AM		100	180	225	125	95	320	250	65	15	14	750	332	405	810	354	480	160,5		
100		50-125 B	65	50	100	132	160	100	70	240	190	50	12	14	525	250	292	602	263	395	57,5
100	50-125 B				100	132	160	100	70	240	190	50	12	14	560	250	292	602	263	395	53,5
112		50-125 A			100	132	160	100	70	240	190	50	12	14	610	250	292	602	263	395	65,5
100	50-125 A				100	132	160	100	70	240	190	50	12	14	560	250	292	602	263	395	57,5
112	50-160 B1				100	160	180	100	70	265	212	50	12	14	597	270	340	627	287	408	68,5
132	50-160 B				100	160	180	100	70	265	212	50	12	14	590	270	340	627	287	408	74,5
112	50-160 A1				100	160	180	100	70	265	212	50	12	14	597	270	340	627	287	408	74,5
132	50-160 A				100	160	180	100	70	265	212	50	12	14	590	270	340	627	287	408	81
132	50-200 C				100	160	200	100	70	265	215	50	12	14	635	290	360	666	346	471	98
132	50-200 B				100	160	200	100	70	265	215	50	12	14	635	290	360	666	346	471	102,5
132	50-200 A1				100	160	200	100	70	265	215	50	12	14	680	290	360	810	354	480	107
160	50-200 A				100	160	200	100	70	265	215	50	12	14	705	290	360	810	354	480	132,5

MEC	3- TYPE	1- TYPE	DIMENSIONS (mm)																				
			DNA	DNM	a	h1	h2	m1	m2	n1	n2	b	x	s	C	B	H	I	L			M	
132	50-250 C1		65	50	100	180	225	125	95	320	250	65	14	14	680	332	405	810	354	480	113,5		
160	50-250 C				100	180	225	125	95	320	250	65	14	14	705	332	405	810	354	480	139		
160	50-250 B				100	180	225	125	95	320	250	65	14	14	750	332	405	810	354	480	154		
160	50-250 A				100	180	225	125	95	320	250	65	14	14	750	332	405	810	354	480	164		
112	65-125 B1		80	65	100	160	180	125	95	280	212	65	14	14	612	280	340	627	287	408	70		
132	65-125 B				100	160	180	125	95	280	212	65	14	14	605	280	340	627	287	408	76,5		
112	65-125 A1				100	160	180	125	95	280	212	65	14	14	612	280	340	627	287	408	76,5		
132	65-125 A				100	160	180	125	95	280	212	65	14	14	605	280	340	627	287	408	83		
132	65-160 C				100	160	200	125	95	280	212	65	14	14	635	290	360	666	346	471	99,5		
132	65-160 B				100	160	200	125	95	280	212	65	14	14	635	290	360	666	346	471	103,5		
132	65-160 A1				100	160	200	125	95	280	212	65	14	14	680	290	360	810	354	480	107,5		
160	65-160 A				100	160	200	125	95	280	212	65	14	14	705	290	360	810	354	480	135		
132	65-200 C1				100	180	225	125	95	320	250	65	14	14	680	330	405	810	354	480	113		
160	65-200 C				100	180	225	125	95	320	250	65	14	14	705	330	405	810	354	480	138,5		
160	65-200 B				100	180	225	125	95	320	250	65	14	14	750	330	405	810	354	480	153		
160	65-200 A				100	180	225	125	95	320	250	65	14	14	750	330	405	810	354	480	163,5		
180	65-250 B				100	200	250	160	120	360	280	80	16	19	820	370	450	920	420	625	203,5		
180	65-250 A				100	200	250	160	120	360	280	80	16	19	860	370	450	920	420	625	226		
132	80-160 E				100	80	125	180	225	125	95	320	250	65	14	14	665	330	405	810	354	480	110
132	80-160 D						125	180	225	125	95	320	250	65	14	14	665	330	405	810	354	480	114
132	80-160 C1		125	180			225	125	95	320	250	65	14	14	710	330	405	810	354	480	118		
160	80-160 C		125	180			225	125	95	320	250	65	14	14	735	330	405	810	354	480	143		
160	80-160 B		125	180			225	125	95	320	250	65	14	14	780	330	405	810	354	480	157,5		
160	80-160 A		125	180			225	125	95	320	250	65	14	14	780	330	405	810	354	480	168		
180	80-200 B		125	180			250	125	95	345	280	65	16	14	840	355	430	920	420	625	200		
180	80-200 A		125	180			250	125	95	345	280	65	16	14	880	355	430	920	420	625	222		
180	100-160 B		125	100	125	200	280	160	120	360	280	80	18	18	842	390	480	920	420	625	208		
180	100-160 A				125	200	280	160	120	360	280	80	18	18	882	390	480	920	420	625	230,5		

DIMENSIONS (mm)				
DN	D	K	holes	
			n°	Ø
32	140	100	4	18
40	150	110	4	18
50	165	125	4	18
65	185	145	4	18
80	200	160	8	18
100	220	180	8	18
125	250	210	8	18

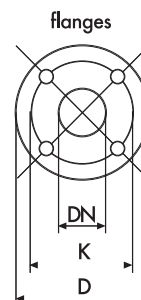

TYPE	LOTS			
	TRUCK		CONTAINER	
	PALLET (cm)	N° pumps	PALLET (cm)	N° pumps
32-160	80×120×155	24	80×120×190	30
32-200 (C)	80×120×155	24	80×120×180	24
32-200 (A) (A1) (B) (B1)	100×120×140	18	100×120×185	24
32-250 (A)	85×110×120	6	85×110×170	9
32-250 (B) (C)	80×120×120	6	80×120×170	9
40-125	80×120×155	24	80×120×190	30
40-160	80×120×155	24	80×120×190	30
40-200	100×120×140	18	100×120×185	24
40-250 (A)	85×110×120	6	85×110×170	9
40-250 (B) (BM) (C)	80×120×120	6	80×120×170	9
50-125	80×120×120	24	80×120×180	24
50-160	100×120×140	18	100×120×185	24
50-200 (A)	85×110×120	6	85×110×170	9
50-200 (B) (C)	80×120×120	6	80×120×170	9
50-250	80×120×120	6	80×120×170	9
65-125	100×120×140	18	100×120×185	24
65-160	85×110×120	6	85×110×170	9
65-200	85×110×120	6	85×110×170	9
65-250	85×110×130	4	85×110×190	6
80-160	85×110×120	6	85×110×170	9
80-200	85×110×130	4	85×110×190	6
100-160	85×110×130	4	85×110×190	6

MN Serie-Mechanical seal and bearings

MECHANICAL SEAL	PUMP MODEL	SHAFT Ø		STANDARD MATERIAL	OPTIONAL			
					E	V	2E	2V
	32-160, 40-125	20mm	Rotating face Stationary face Elastomer	Ceramic Graphite NBR	Ceramic Graphite EPDM	- - -	SiC SiC EPDM	SiC SiC FKM
	40-250M	28mm	Rotating face Stationary face Elastomer	Ceramic Graphite EPDM	- - -	- - -	SiC SiC EPDM	SiC SiC FKM
	32-200, 32-250, 40-160, 40-160P, 40-200, 40-200P, 40-250, 50-125, 50-160, 50-200, 50-250, 65-125, 65-160, 65-200, 80-160	28mm	Rotating face Stationary face Elastomer	Ceramic Graphite NBR	Ceramic Graphite EPDM	Ceramic Graphite FKM	SiC SiC EPDM	SiC SiC FKM
	65-250, 80-200, 100-160	40mm	Rotating face Stationary face Elastomer	CrNi-steel Graphite NBR	CrNi-steel Graphite EPDM	CrNi-steel Graphite FKM	SiC SiC EPDM	SiC SiC FKM

BEARINGS	PUMP MODEL	TYPE	
	32-200C, 40-160B, 40-160A, 50-125B, 50-125A	6204-ZZ	6206-ZZ C3
	32-160C, 32-160B, 32-160A, 40-125C, 40-125B, 40-125A	6205-ZZ C3	6203-ZZ
	1- 32-200C, 32-200B1, 32-200B, 32-200A1, 32-200A, 32-250C, 32-250B, 1- 40-160A, 40-160AP, 40-200B1, 40-200B, 40-200A1, 40-200A, 40-200AP, 40-250C, 40-250B, 1- 50-125A, 50-160B1, 50-160B, 50-160A1, 50-160A, 50-200C, 50-200B, 65-125B1, 65-125B, 65-125A1, 65-125A, 65-160C, 65-160B, 80-160E, 80-160D	6206-ZZ C3	6306-ZZ C3
	32-250A1, 40-250A1, 50-200A1, 50-200C1, 65-160A1, 65-200C1, 80-160C1	6308-ZZ C3	6306-ZZ C3
	32-250A, 40-250A, 40-250BM, 40-250AM, 50-200A, 50-250C, 50-250B, 50-250A, 65-160A, 65-200C, 65-200B, 65-200A, 80-160C, 80-160B, 80-160A	6308-ZZ C3	6309-ZZ C3
	65-250B, 65-250A, 80-200B, 80-200A, 100-160B, 100-160A	6309-ZZ C3	6310-ZZ C3