

Scope of Performance LVS (R)

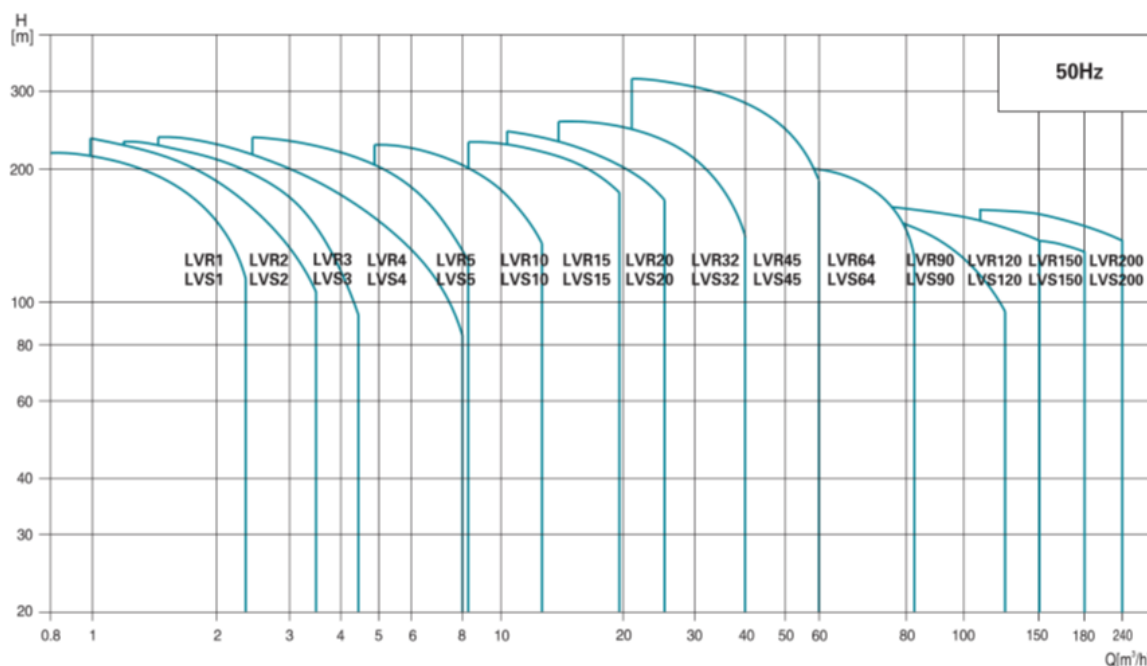

Product Range

MODEL	LVR(S)1	LVR(S)2	LVR(S)3	LVR(S)4	LVR(S)5	LVR(S)10	LVR(S)15	LVR(S)20	LVR(S)32	LVR(S)45	LVR(S)64	LVR(S)90	LVR(S)120	LVR(S)150	LVR(S)200
DESCRIPTION															
Rated flow [m ³ /h]	1	2	3	4	5	10	15	20	32	45	64	90	120	150	200
Flow range [m ³ /h]	0.7-2.4	1.0-3.5	1.2-4.5	1.5-8	2.5-8.5	5-13	8-23	10.5-29	15-40	22-58	30-85	45-120	60-150	80-180	100-240
Max. pressure [bar]	22	23	24	21	24	22	23	25	28	33	22	20	16	16	16
Motor power [kW]	0.37-2.2	0.37-3	0.37-3	0.37-4	0.37-4	1.1-7.5	1.1-15	1.1-18.5	1.5-30	3-45	4-45	5.5-45	11-75	11-75	18.5-110
Temperature Range [°C]	-20°C--+120°C (Note: Both the Max. permissible pressure and liquid temperature range refer to the pump capacity.)														
Max. pump efficiency [%]	45	46	55	59	60	65	70	72	78	79	80	81	74	73	79
Pipe connection-LVR															
Oval flange	G1	G1	G1	G1 1/4	G1 1/4	-	-	-	-	-	-	-	-	-	-
DIN flange	DN25	DN25	DN25	DN32	DN32	DN40	DN50	DN50	DN65	DN80	DN100	DN100	DN125	DN125	DN150
Pipe connection-LVS															
Oval flange	-	-	-	-	-	-	-	-	-	-	-	-	-	-	-
DIN flange	DN32	DN32	DN32	DN32	DN32	DN40	DN50	DN50	DN65	DN80	DN100	DN100	DN125	DN125	DN150
Clamp connector	φ42	φ42	φ42	φ42	φ42	-	-	-	-	-	-	-	-	-	-
Threaded connector	R ₂ 1 1/4	R ₂ 1 1/4	R ₂ 1 1/4	R ₂ 1 1/4	R ₂ 1 1/4	-	-	-	-	-	-	-	-	-	-

Ambient Temperature

An ambient temperature of over 40 ° C or an installation at an altitude above 1000 meters above sea level requires an oversized motor. Due to low air density and poor cooling, the output power P₂ decreases, as shown in the table below:

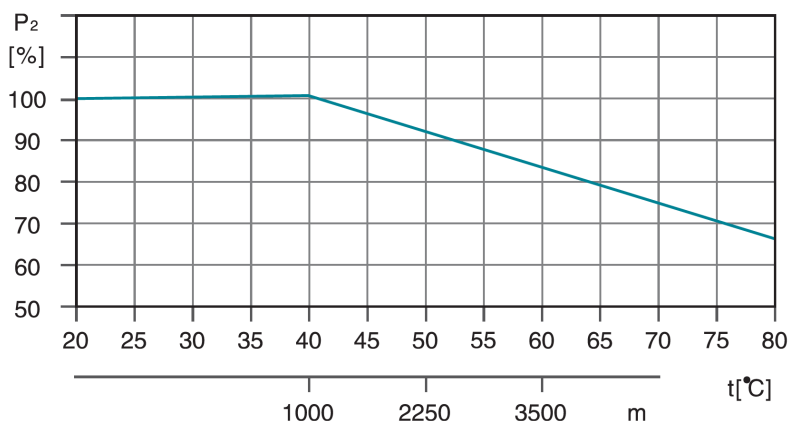

For example, when the pump is installed at an altitude of 3500 meters, P₂ will decrease by 88%. And when the ambient temperature is 70 ° C, P₂ will decrease by 78%.

Maximum Operation pressure (bar)

The table below shows the maximum discharge pressures of the various LVS (R) pumps. The suction pressure of the pump + the set pressure must always be lower than the maximum operating pressure of the pump. If the maximum working pressure is exceeded, it can damage the motor bearings and reduce the service life of the mechanical seal.

Model	LVR Max. Operation pressure [bar]		LVS Max. Operation pressure [bar]
	Oval Flange	DIN Flange	
LVR (S) 1	16	25	25
LVR (S) 2	16	25	25
LVR (S) 3	16	25	25
LVR (S) 4	16	25	25
LVR (S) 5	16	25	25
LVR (S) 10		25	25
LVR (S) 15		25	25
LVR (S) 20		25	25
LVR (S) 32-1-1 - 32-7	16		16
LVR (S) 32-8-2 - 32-14	30		30
LVR (S) 45-1-1 - 45-5	16		16
LVR (S) 45-6-2 - 45-11	30		30
LVR (S) 45-12-2 - 45-13-2	33		33
LVR (S) 64-1-1 - 64-5	16		16
LVR (S) 64-6-2 - 64-8-1	30		30
LVR (S) 90-1-1 - 90-4	16		16
LVR (S) 90-5-2 - 90-6	30		30
LVR (S) 120-1 - 120-7	20		20
LVR (S) 150-1-1 - 150-6	20		20
LVR (S) 200-1-D - 200-4	20		20

NPSH

Minimum Inlet Pressure–Npsh

Calculation of the inlet pressure “H” is recommended in these situations:

- The liquid temperature is high.
- The flow is significantly higher than the rated flow.
- Water is drawn from depths.
- Water is drawn through long pipes.
- Inlet conditions are poor.

To avoid cavitation, make sure that there is a minimum pressure on the suction side of the pump. The maximum suction lift “H” in meters head can be calculated as follows:

$$H = P_b \times 10.2 - NPSH - H_f - H_v - H_s$$

P_b = Barometric pressure in bar. (Barometric pressure can be set to 1 bar). In closed systems, P_b indicates the system pressure in bar.

NPSH = Net Positive Suction Head in meters head. (To be read from the NPSH curve at the highest flow the pump will be delivering.)

H_f = Friction loss in suction pipe in meters head. (At the highest flow the pump will be delivering.)

H_v = Vapor pressure in meters head. (To be read from the vapor pressure scale. “ H_v ” depends on the liquid temperature “ t_m ”)

H_s = Safety margin=minimum 0.5 meters head.

If the “H” calculated is positive, the pump can operate at a suction lift of maximum “H” meters head.

If the “H” calculated is negative, an inlet pressure of minimum “H” meters head is required.

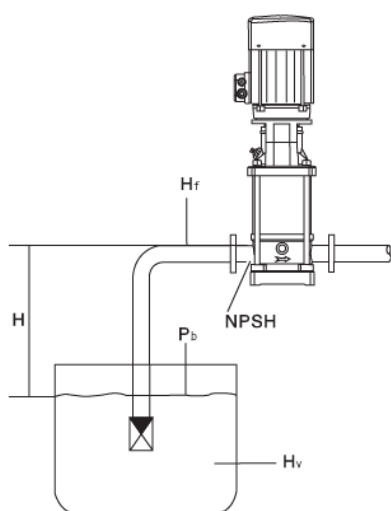

t_m [°C]	H_v [m]
190	126
180	100
170	79
160	62
150	45
140	40
140	35
130	30
130	25
120	20
110	15
100	12
100	10
90	8.0
90	6.0
80	5.0
80	4.0
70	3.0
60	2.0
50	1.5
50	1.0
40	0.8
40	0.6
30	0.4
30	0.3
20	0.2
10	0.1
0	0

Note: To avoid cavitation, never select a pump with a duty point too far to the right on the NPSH curve. Always check the NPSH value of the pump at the highest possible flow.

LVR32 Vertical multicellular pump, water box and pump base in cast iron



LVR

Application

- Transfer of liquids with low viscosity, non-flammable and non-explosive, not containing solid particles or fibers. These liquids must not chemically attack the materials of the pump.
- Water supply for tall buildings, pumping stations, overpressure
- Washing stations, heating water circulation, air conditioning water circulation, water treatment systems
- Distillation systems, municipal swimming pools
- Irrigation: sprinkling, drip
- Industry
- Fire fighting systems

Pompe

- Liquid temperature: from -20°C to $+120^{\circ}\text{C}$
- Nominal flow: $32\text{ m}^3/\text{h}$
- maximum pressure: 28 bars
- pH between 4 and 10

Moteur

- IE3 motor
- Protection class: IP55
- Maximum ambient temperature: $+40^{\circ}$

Identification codes

LVR	32	-10	-2	-B	/F	
						DIN flange
						inox 316 (by default, inox 304)
						number of small turbines
						number of turbines
						Nominal flow (m^3/h)
						vertical multicellular pump in cast iron

Technical data

MODEL	kW	Q (m ³ /h)		Q (l/min)		15		20		25		32		35		40	
		250	333	417	533	583	667										
LVRm32-1-1/F	1.5	15	14	13	10	8	5										
LVR32-1-1/F	1.5	15	14	13	10	8	5										
LVRm32-1/F	2.2	18	17	16	13	11.5	9										
LVR32-1/F	2.2	18	17	16	13	11.5	9										
LVRm32-2-2/F	3	31	29.5	26.5	20.5	17.5	12										
LVR32-2-2/F	3	31	29.5	26.5	20.5	17.5	12										
LVR32-2/F	4	37	35.5	32.5	27.5	25	19.5										
LVR32-3-2/F	5.5	50	47	43.5	35.5	31	22.5										
LVR32-3/F	5.5	55.5	53	49	41.5	37.5	29.5										
LVR32-4-2/F	7.5	68.5	65	60	49.5	44	32.5										
LVR32-4/F	7.5	74.5	70.5	66	56	50.5	40										
LVR32-5-2/F	11	88.5	84.5	78	65.5	58.5	45										
LVR32-5/F	11	94.5	90	84	72	65	52										
LVR32-6-2/F	11	107	102	94.5	79.5	71	55										
LVR32-6/F	11	113	108	100	85.5	77.5	61.5										
LVR32-7-2/F	15	127	121	112	94.5	85	66.5										
LVR32-7/F	15	133	126	118	101	92	73.5										
LVR32-8-2/F	15	145	138	128	108	98	76.5										
LVR32-8/F	15	151	144	134	115	104	83										
LVR32-9-2/F	18.5	165	158	147	124	112	88.5										
LVR32-9/F	18.5	171	163	152	131	119	95.5										
LVR32-10-2/F	18.5	184	175	163	138	125	98.5										
LVR32-10/F	18.5	190	181	169	145	133	106										
LVR32-11-2/F	22	203	194	181	154	140	111										
LVR32-11/F	22	209	200	187	161	147	118										
LVR32-12-2/F	22	222	212	197	168	152	121										
LVR32-12/F	22	227	217	203	176	160	128										
LVR32-13-2/F	30	244	233	218	187	169	136										
LVR32-13/F	30	250	239	224	193	177	145										
LVR32-14-2/F	30	263	251	234	201	183	146										
LVR32-14/F	30	269	258	241	207	188	156										

Hydraulic performance

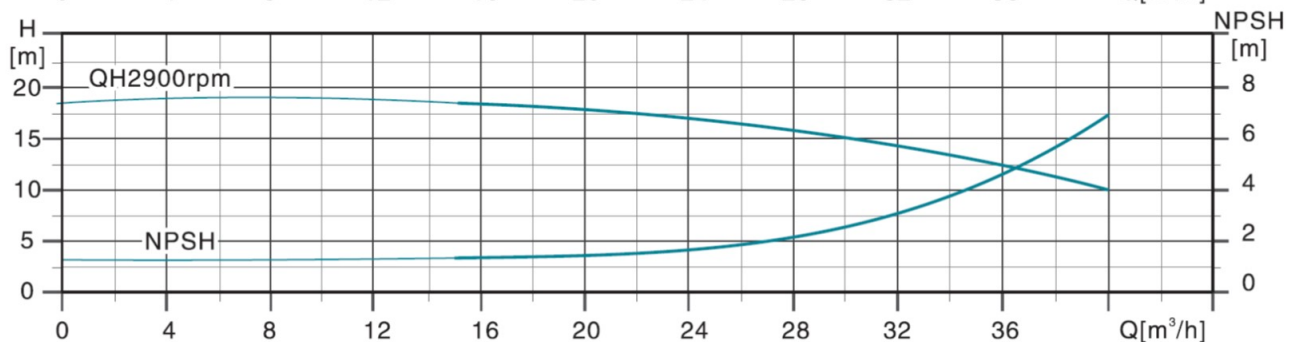
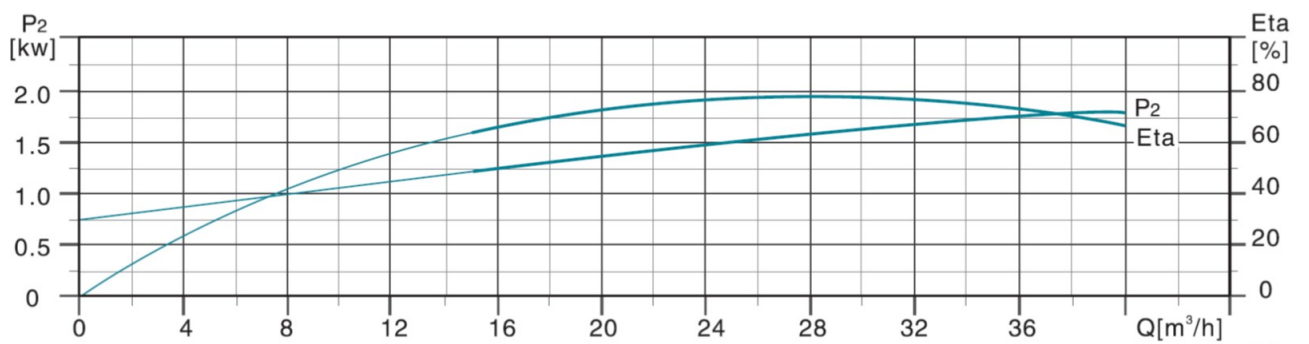
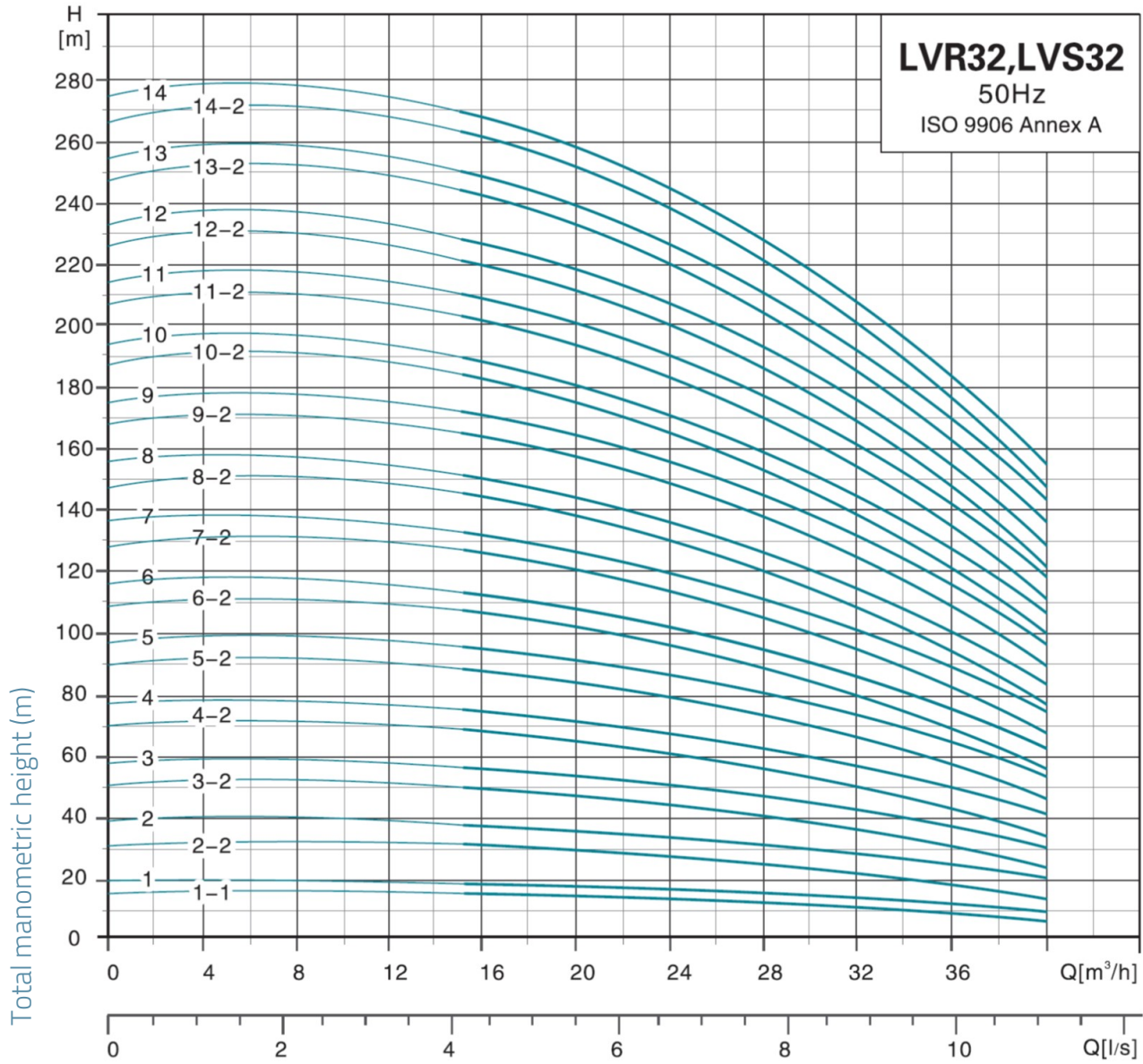

Dimensions

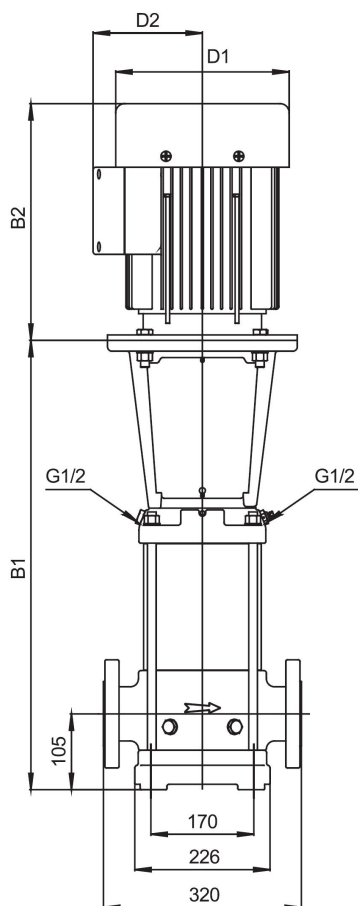

MODEL	B1	B1+B2	D1	D2	poids
LVRm32-1-1/F	455	773	164	127	61.7
LVR32-1-1/F	455	773	164	127	61.7
LVRm32-1/F	455	773	164	127	63.7
LVR32-1/F	455	773	164	127	63.7
LVRm32-2-2/F	525	865	186	120	72.6
LVR32-2-2/F	525	865	186	120	72.6
LVR32-2/F	525	865	186	120	74.9
LVR32-3-2/F	645	1042	210	142	100.9
LVR32-3/F	645	1042	210	142	100.6
LVR32-4-2/F	715	1112	210	142	108.7
LVR32-4/F	715	1112	210	142	108.7
LVR32-5-2/F	895	1394	254	175	149.2
LVR32-5/F	895	1394	254	175	149.2
LVR32-6-2/F	965	1464	254	175	152.1
LVR32-6/F	965	1464	254	175	152.1
LVR32-7-2/F	1035	1534	254	175	167.6
LVR32-7/F	1035	1534	254	175	167.6
LVR32-8-2/F	1105	1604	254	175	170.7
LVR32-8/F	1105	1604	254	175	170.7
LVR32-9-2/F	1175	1735	330	250	221.6
LVR32-9/F	1175	1735	330	250	221.6
LVR32-10-2/F	1245	1805	330	250	224.5
LVR32-10/F	1245	1805	330	250	224.5
LVR32-11-2/F	1315	1915	380	280	263.3
LVR32-11/F	1315	1915	380	280	263.4
LVR32-12-2/F	1385	1985	380	280	266.2
LVR32-12/F	1385	1985	380	280	266.2
LVR32-13-2/F	1455	2135	420	305	323.6
LVR32-13/F	1455	2135	420	305	323.6
LVR32-14-2/F	1525	2205	420	305	326.5
LVR32-14/F	1525	2205	420	305	326.5

Exploded view

No.	Type	Materials
1	Lower water box	cast iron HT200
2	Flange	ZG35 cast steel
3	Diffuser	AISI 304 stainless steel
4	Diffuser with bearing	AISI 304 stainless steel
5	Intermediate diffuser	AISI 304 stainless steel
6	Impeller	AISI 304 stainless steel
7	Shaft sleeve	
8	Diffuser	AISI 304 stainless steel
9	Drain plug	AISI 304 stainless steel
10	Lantern	cast iron HT200
11	Engine	
12	Coupling protection housing	AISI 304 stainless steel
13	Coupling	QT400 cast iron
14	Cartridge mechanical seal	
15	Cover	cast iron HT200
16	Filling plug	AISI 304 stainless steel
17	Clamping plate	AISI 304 stainless steel
18	Jacket	AISI 304 stainless steel
19	Pump shaft	AISI 304 stainless steel

