

Scope of Performance LVS (R)

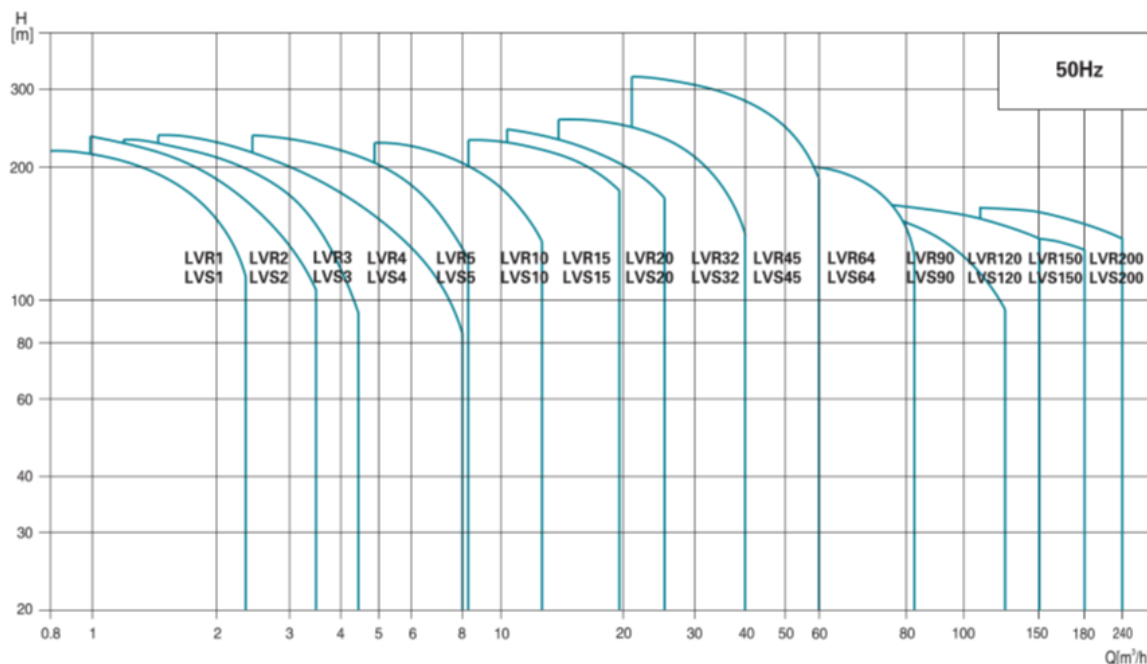

Product Range

MODEL	LVR(S)1	LVR(S)2	LVR(S)3	LVR(S)4	LVR(S)5	LVR(S)10	LVR(S)15	LVR(S)20	LVR(S)32	LVR(S)45	LVR(S)64	LVR(S)90	LVR(S)120	LVR(S)150	LVR(S)200
DESCRIPTION															
Rated flow [m³/h]	1	2	3	4	5	10	15	20	32	45	64	90	120	150	200
Flow range [m³/h]	0.7-2.4	1.0-3.5	1.2-4.5	1.5-8	2.5-8.5	5-13	8-23	10.5-29	15-40	22-58	30-85	45-120	60-150	80-180	100-240
Max. pressure [bar]	22	23	24	21	24	22	23	25	28	33	22	20	16	16	16
Motor power [kW]	0.37-2.2	0.37-3	0.37-3	0.37-4	0.37-4	1.1-7.5	1.1-15	1.1-18.5	1.5-30	3-45	4-45	5.5-45	11-75	11-75	18.5-110
Temperature Range [°C]	-20°C--+120°C (Note: Both the Max. permissible pressure and liquid temperature range refer to the pump capacity.)														
Max. pump efficiency [%]	45	46	55	59	60	65	70	72	78	79	80	81	74	73	79
Pipe connection-LVR															
Oval flange	G1	G1	G1	G1 1/4	G1 1/4	-	-	-	-	-	-	-	-	-	-
DIN flange	DN25	DN25	DN25	DN32	DN32	DN40	DN50	DN50	DN65	DN80	DN100	DN100	DN125	DN125	DN150
Pipe connection-LVS															
Oval flange	-	-	-	-	-	-	-	-	-	-	-	-	-	-	-
DIN flange	DN32	DN32	DN32	DN32	DN32	DN40	DN50	DN50	DN65	DN80	DN100	DN100	DN125	DN125	DN150
Clamp connector	φ42	φ42	φ42	φ42	φ42	-	-	-	-	-	-	-	-	-	-
Threaded connector	R ₂ 1 1/4	R ₂ 1 1/4	R ₂ 1 1/4	R ₂ 1 1/4	R ₂ 1 1/4	-	-	-	-	-	-	-	-	-	-

Ambient Temperature

An ambient temperature of over 40 ° C or an installation at an altitude above 1000 meters above sea level requires an oversized motor. Due to low air density and poor cooling, the output power P₂ decreases, as shown in the table below:

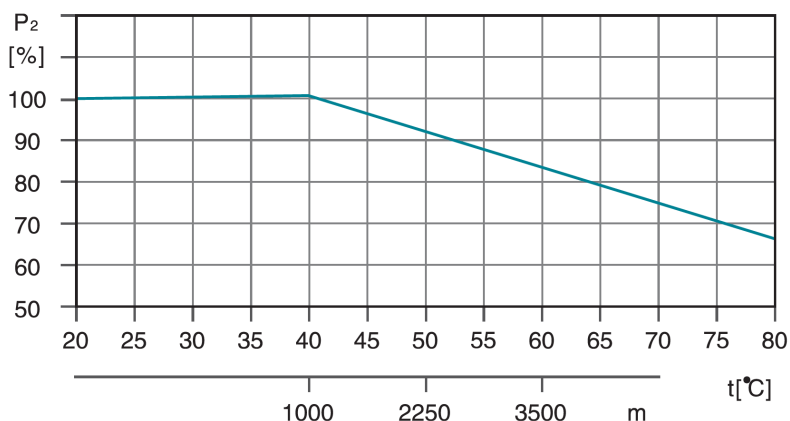

For example, when the pump is installed at an altitude of 3500 meters, P₂ will decrease by 88%. And when the ambient temperature is 70 ° C, P₂ will decrease by 78%.

Maximum Operation pressure (bar)

The table below shows the maximum discharge pressures of the various LVS (R) pumps. The suction pressure of the pump + the set pressure must always be lower than the maximum operating pressure of the pump. If the maximum working pressure is exceeded, it can damage the motor bearings and reduce the service life of the mechanical seal.

Model	LVR Max. Operation pressure [bar]		LVS Max. Operation pressure [bar]
	Oval Flange	DIN Flange	
LVR (S) 1	16	25	25
LVR (S) 2	16	25	25
LVR (S) 3	16	25	25
LVR (S) 4	16	25	25
LVR (S) 5	16	25	25
LVR (S) 10		25	25
LVR (S) 15		25	25
LVR (S) 20		25	25
LVR (S) 32-1-1 - 32-7	16		16
LVR (S) 32-8-2 - 32-14	30		30
LVR (S) 45-1-1 - 45-5	16		16
LVR (S) 45-6-2 - 45-11	30		30
LVR (S) 45-12-2 - 45-13-2	33		33
LVR (S) 64-1-1 - 64-5	16		16
LVR (S) 64-6-2 - 64-8-1	30		30
LVR (S) 90-1-1 - 90-4	16		16
LVR (S) 90-5-2 - 90-6	30		30
LVR (S) 120-1 - 120-7	20		20
LVR (S) 150-1-1 - 150-6	20		20
LVR (S) 200-1-D - 200-4	20		20

NPSH

Minimum Inlet Pressure–Npsh

Calculation of the inlet pressure “H” is recommended in these situations:

- The liquid temperature is high.
- The flow is significantly higher than the rated flow.
- Water is drawn from depths.
- Water is drawn through long pipes.
- Inlet conditions are poor.

To avoid cavitation, make sure that there is a minimum pressure on the suction side of the pump. The maximum suction lift “H” in meters head can be calculated as follows:

$$H = P_b \times 10.2 - NPSH - H_f - H_v - H_s$$

P_b = Barometric pressure in bar. (Barometric pressure can be set to 1 bar). In closed systems, P_b indicates the system pressure in bar.

NPSH = Net Positive Suction Head in meters head.
(To be read from the NPSH curve at the highest flow the pump will be delivering.)

H_f = Friction loss in suction pipe in meters head.
(At the highest flow the pump will be delivering.)

H_v = Vapor pressure in meters head. (To be read from the vapor pressure scale. “ H_v ” depends on the liquid temperature “ t_m ”)

H_s = Safety margin=minimum 0.5 meters head.

If the “H” calculated is positive, the pump can operate at a suction lift of maximum “H” meters head.

If the “H” calculated is negative, an inlet pressure of minimum “H” meters head is required.

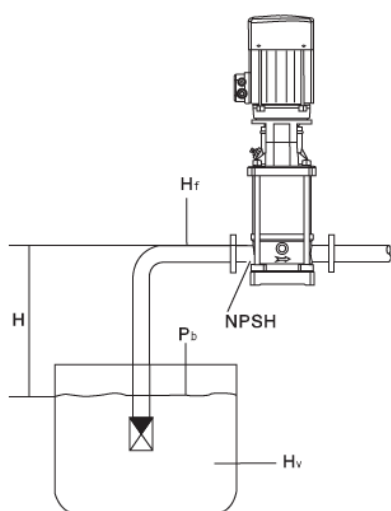

t_m [°C]	H_v [m]
190	126
180	100
170	79
160	62
150	45
140	40
140	35
130	30
130	25
120	20
110	15
100	12
100	10
90	8.0
90	6.0
80	5.0
80	4.0
70	3.0
60	2.0
50	1.5
50	1.0
40	0.8
40	0.6
30	0.4
30	0.3
20	0.2
10	0.1
0	0

Note: To avoid cavitation, never select a pump with a duty point too far to the right on the NPSH curve. Always check the NPSH value of the pump at the highest possible flow.

EVP6H vertical multicellular pump in cast iron



Application

- Water supply for tall buildings, pumping stations, overpressure
- Washing stations, heating water circulation, air conditioning water circulation, water treatment systems
- Irrigation: sprinkling, drip
- Fire fighting systems

Pompe

- Use for a wide range of temperatures, flow rates and HMT
- Inlet and outlet can be on the same side or opposite, depending on the needs of the installation
- Simplified installation and maintenance
- Inlet and outlet in cast iron, anti-corrosion treatment (cataphoresis)

Moteur

- Liquid temperature: from +5°C to +60°C
- Max ambient temperature: +40°C
- maximum pressure: 15 bars

Identification codes

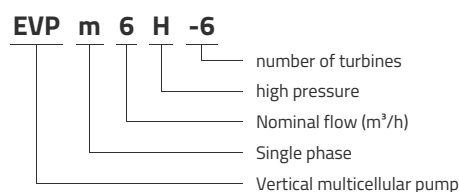

Technical data

MODEL	kW	Q (m ³ /h)	0	1	2	3	4.5	6	7.5	9	10.5
		Q (l/min)	0	17	33	50	75	100	125	150	175
EVPm6H-3	1.1	39	38	37	35	33	29	24	18	10	
EVP6H-3	1.1	39	38	37	35	33	29	24	18	10	
EVPm6H-4	1.5	52	51	49	47	44	39	32	25	14	
EVP6H-4	1.5	52	51	49	47	44	39	32	25	14	
EVPm6H-5	1.8	65	62	60	58	54	47	38	28	16	
EVP6H-5	1.8	65	62	60	58	54	47	38	28	16	
EVP6H-6	2.2	76	74	71	68	63	56	45	34	20	
EVP6H-8	3	103	100	97	95	90	80	66	50	31	
EVP6H-10	4	130	127	124	121	114	103	86	66	41	

Dimensions

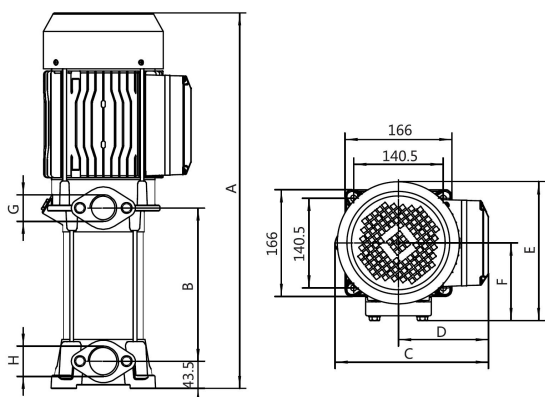

MODEL	A	B	C	D	E	F	G	H
EVPm6H-3	457	158.5	210	125	202	114.5	1¼	1½
EVP6H-3	457	158.5	210	125	202	114.5	1¼	1½
EVPm6H-4	483.5	185	210	125	202	114.5	1¼	1½
EVP6H-4	483.5	185	210	125	202	114.5	1¼	1½
EVPm6H-5	510	211.5	210	125	202	114.5	1¼	1½
EVP6H-5	510	211.5	210	125	202	114.5	1¼	1½
EVP6H-6	536.5	238	210	125	202	114.5	1¼	1½
EVP6H-8	655	297.5	240	141	218	121.5	1¼	1½
EVP6H-10	708	350.5	240	141	218	121.5	1¼	1½

Hydraulic performance

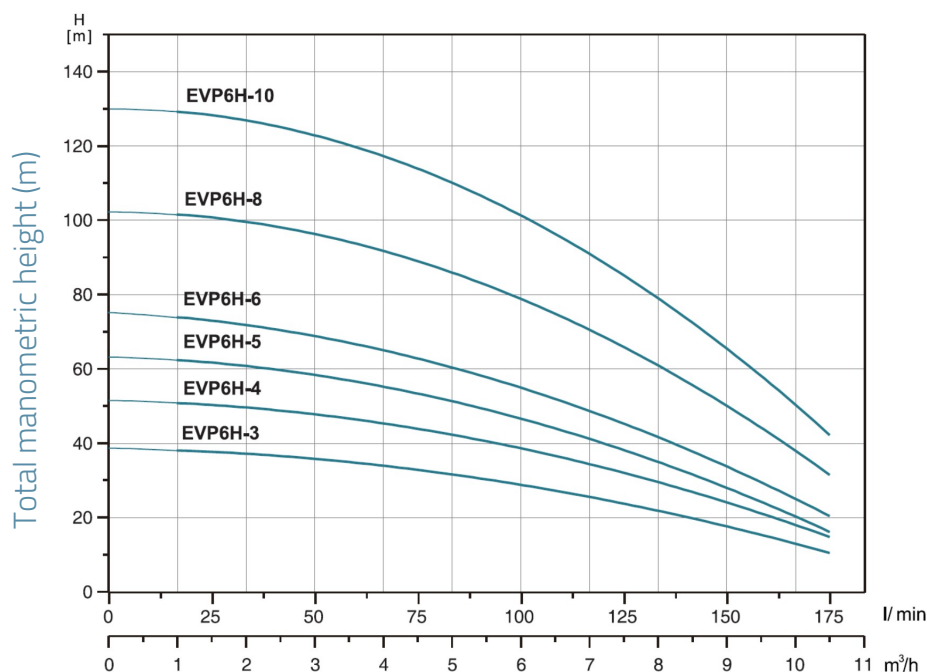

Exploded view

No.	Type	Materials
1	Fan cover	O8F steel
2	Fan	polypropylene
3	Rear cover	cast iron HT200
4	Bearing	
5	Stator	
6	Rotor	
7	Seal	nitrile rubber (NBR)
8	Flange	cast iron HT200
9	Upper water box	aluminium
10	Mechanical seal	carbon / ceramic
11	Jacket	AISI 304 stainless steel
12	Impeller	noryl (PPO)
13	Diffuser	noryl (PPO)
14	Diffuser	noryl (PPO)
15	Electric box cover	PA6 resin

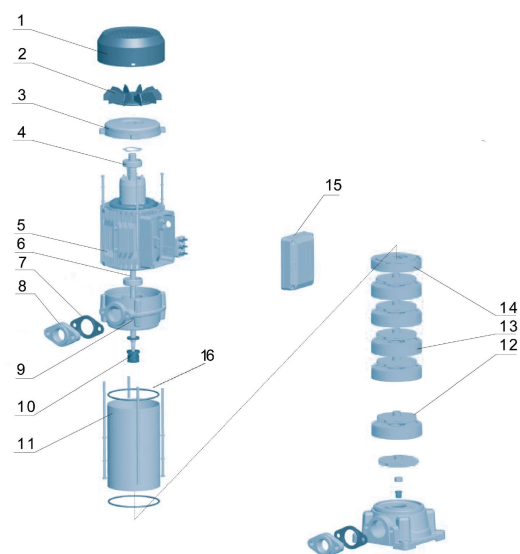

Packaging

MODEL	Weight (kg)	Length L (mm)	Width W (mm)	Height H (mm)
EVPm6H-3	21.2	535	248	255
EVP6H-3	21.2	535	248	255
EVPm6H-4	22.9	560	248	255
EVP6H-4	22.9	560	248	255
EVPm6H-5	24.3	585	248	255
EVP6H-5	24.3	585	248	255
EVP6H-6	25.2	615	248	255
EVP6H-8	41.6	790	330	370
EVP6H-10	45.6	790	330	370